

SERRALUNGA
MADE IN ITALY

Since 1825



2 0 2 3

SERRALUNGA
MADE IN ITALY Since 1825

2 0 2 3
C A T A L O G U E

INDEX

	SERRALUNGA	8	
	DESIGNERS	12	
MOLESKIN	MOLESKIN	14	
14-31			
ART	FAITUTTOTU	34	
32-67	FLOW	38	
	HIC!	42	
	HOLLY ALL	44	275
	KEW	48	
	MISSED TREE	50	386
	NEW_WAVE	54	
	RIPPLE	58	
	SANTAVASE	62	
	THE VASES	64	
URBAN FURNITURE	CONE	70	
68-85	PRIMAVERA	72	
	VAS FAMILY & BIG-BO	74	211, 329
	VERSAILLES	82	
POTS	BORDATO LISCIO	90	100
86-191	CAMELIA	94	
	CASSERO	98	239
	CUBOTTI	104	190
	CUP	110	376, 417
	EUFRONIO	114	236
> POTS	FENCE	118	190
	GRAND JANE	122	
	GRAND MARY	122	
	GREEN PILLS	124	
	INORBITA	128	
	JUNE	130	238

	KABIN	132	266
	LISCIO SIENA	136	
	LLUNA	140	
	MARCANTONIO	142	248
	MEMORY POT	146	
	MING	150	25, 158, 212, 253, 399
	NEOCLASSIC	156	
	NEWPOT	160	27
	PISA	168	
	POT AU MUR	172	
	SCARLETT	174	400, 402
	SEVRES	176	
	TORRE	180	190
	TUBINI	184	
	UOVO DI COLOMBO	186	
	VASO		
	RETTANGOLARE O/E	188	
ARMCHAIRS & SOFA			
196–243	BAY	194	20, 111, 274, 293, 376
	BELLE ÉTOILE	200	
	CANISSE	208	380
	DOLCEVITA	210	300, 319, 417
	HOUR	216	76, 231, 266
	ONE SLIM	218	203, 231
	PINE BEACH	224	18, 284, 293, 391
	SIRCHESTER	230	21, 28, 29, 275, 277, 332, 401, 403
	TIMEOUT	238	288
CHAIRS			
240–263	CROISETTE	234	102, 259, 261, 267, 270, 387, 398
	KUBRICK	240	266, 277
	REGISTA	242	262, 265, 266
	RUSSEL	246	
	SOLEA	250	253, 385

TABLES & COFFEE TABLES

254–295

BANQUÉTÉ	258	252
DUETTO	260	235, 387, 398
LOU LOU	264	102, 236, 238, 247, 253
NOTREDAME	268	258
SOLEA-T	270	
COUNTER BAR	272	
DADO	276	
HANDY 45	280	
JUJU	282	16, 19, 24, 195, 196, 219, 220, 222, 274, 293, 345, 376, 391
LOU LOU	286	201, 204, 275, 312
METEOR	290	
MILO LOW	294	

POOL / BEACH/SPA

296–323

> POOL / BEACH

AQUA	298	29, 316, 319, 392
AQUAPLANO	303	
FIORE DI LOTO	304	
KENTIA	308	197, 253
LAZY	310	278
OASIS	314	248, 316, 392
OLIVIA	318	300
PALENQUERA	320	241
RAMO	322	

BENCHES

324–341

GIULIETTA	326	281, 358
LOOP	330	22
LUBA	334	
ROMEO	338	281

STOOLS

342–351

CERO	344	16, 24, 295
LOUNGE CUBE	346	21, 31, 299, 303
PORCINO	348	

LIGHTS

352–409

ATMOSFERA	356	
AUNT JANE	360	
BONHEUR	362	113, 244, 266
CRYSTAL MOON	366	77, 211, 329
FLAME	368	
FLORET	372	
HONEY	374	
LADY JANE	376	226, 281
LADY MARY	376	
LAMPA-DARIA	382	253
LINDOS	384	235, 263
MISS JANE	388	
ODETTE	390	274
PIC-NIC	394	24, 26
RUFFLE	396	288, 302, 305
SCARLETT	400	174
TOP POT	404	
VAS-THREE	406	

GIFTS

410–439

> GIFTS

BINGO	412	
BONNIE	414	416, 429
CACTUS	416	
DOGGY	420	31, 430
GIANO	424	
NEW WAVE-S	426	
OTTO	428	31
PALOMA	432	
PULCINO	432	
PLOMB	436	
SKAL	438	

POTS**ITALIAN TRADITION**

440–467

DECORATI

444

DOPPIO BORDO

452

GRANIGLIA

454

MILLERIGHE

456

DINGHY SAUCERS

460

ROUND, SQUARE
AND RECTANGULAR
SAUCERS

462

ANFORA RIGATA 446

DECORATO FESTONATO
448

DECORATO FESTONATO

MAIOR 449

DECORATO UVA SPINA 451

ORCIO FESTONATO 447

TECHNICAL DETAILS

468

COLOURS & FABRICS

474

MADE IN ITALY
SINCE 1825

100%
RECYCLABLE



THE FIRST ONES
PRODUCING
VASES WITH
ROTATIONAL
MOULDING IN
ITALY

SERRA

46 DESIGNERS



250 TYPES
OF VASES
FROM ITALIAN
TRADITION TO
INTERNATIONAL
DESIGN

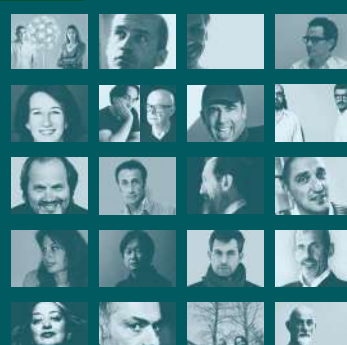

THE FIRST ONES
PRODUCING
BIG VASES
OF FAMOUS
DESIGNERS



THE WORLDWIDE
BIGGEST VASE IN
COLLECTION



THE FIRST ONES
MAKING LIGHTED
VASES

LUNGA

1000

SQUARE
METERS OF
PHOTOVOLTAIC
AREA



AN ITALIAN
COMPANY WITH
TWO CENTURIES
OF FAMILY
HISTORY AND SIX
GENERATIONS

“WE CONSIDER PLASTIC A PRECIOUS MATERIAL AND IT SHOULD BE USED CAREFULLY ONLY WHEN IT MAKES SENSE”

OUR PRODUCTS ARE REUSABLE UNLIMITED TIMES
100% RECYCLABLE

Most of our products are mainly made of 100% mono material: linear low density polyethylene LLDPE resin by rotational molding process. Polyethylene is a 100% recyclable polymer. Consequently, SERRALUNGA products are 100% recyclable and have a long life (over 10 years).

SERRALUNGA uses mainly LLDPE, 100% recyclable and some of our colours are made with recycled materials. As a result our products are reusable unlimited times. The material and its production process makes the products very resistant to extreme temperatures (-35 °C/+80°C; -31°F/+176°F), shocks, UV rays and saline climates.

THE CYCLE OF TRANSFORMATION
A VIRTUOUS CIRCULAR ECONOMY

At the end of their life, our objects can be transformed into plastic powder to give new life to other objects, for “a virtuous circular economy”.

The rotational molding process allows to operate at low temperature and in absence of pressure. Then, a non-forced air cooling completes the production process. Consequently the cycle of transformation is very long, if compared to other moulding technologies, it takes approx. 30 minutes to produce one piece. In this way, the material doesn't undergo thermal shocks due to high temperatures, or physical shocks due to strong cooling and short production cycles. For these reasons a simple polymer such as LLDPE has physical characteristics of high strength, elasticity and durability.





CONSCIOUS PRODUCTION A CONTINUOUS PROCESS

SERRALUNGA uses only raw material transformed in Italy and certificated as per EU legislations. This has a positive impact also on the transport: it allows us to produce lower CO2 emissions.

We recycle our discarded products internally. We have started to use more and more second life LLDPE raw material containing 30% to 70% of regenerated material, without reducing or penalizing the quality and resistance of our objects.

The entire production process is made in SERRALUNGA factory located in Biella (North of Italy). Our production plant is equipped with PHOTOVOLTAIC PANELS that reduce energy consumption to the minimum respecting the environmental Ethics.

SUSTAINABLE - No polluting solvents are employed during the production process

ECOLOGICAL - They are obtained with inert and recyclable raw materials

LONG LASTING - Resistant, Long lasting, Excellent value for money

WEATHER RESISTANT - Products made of polyethylene (LLDPE) by roto molding bear sudden thermal excursions from -35 °C to +80 °C / -31°F/+176°F. Robust and shock resistant.

LIGHT WEIGHT - Easy to handle

MINIMAL MAINTENANCE - Can be cleaned quickly and easily

DESIGNERS



Eero Aarnio



Aquilalberg



Ron Arad



Alessandra Baldereschi



Bazzicalupo - Mangiarotti



Claudio Bellini



Sebastian Bergne



Luisa Bocchietto



Bortolani - Righi



Michel Boucquillon



Calvi - Brambilla

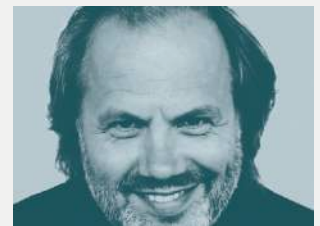

Aldo Cibic



Florent Coirier



Carlo Colombo



Michele De Lucchi



Rodolfo Dordoni



Marta Daza Fernandez



Naoto Fukasawa



Joan Gaspar



Giovanni Jacobone



Zaha Hadid

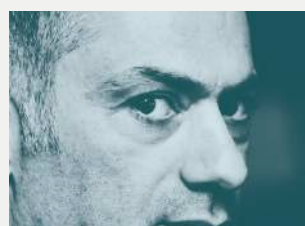

Arik Levy

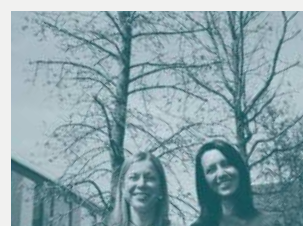

Lineeverdi



Ross Lovegrove

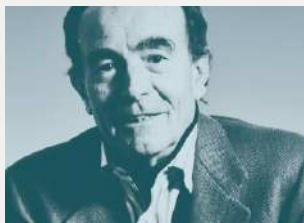

Vico Magistretti



Raffaella Mangiarotti



Jean-Marie Massaud



Alberto Meda



Philippe Nigro



Karim Rashid



Christophe Pillet



Patrizia Pozzi



Andrée e Olivia Putman



Lina Obregon



Paolo Rizzato



Marc Sadler



Marta Sansoni



Denis Santachiara



Ettore Sottsass



Garth Roberts



Massimo Roj



Philippe Starck



Brian Steendyk



Patricia Urquiola



Ionna Vautrin



ZPZ Partners



MOLESKIN

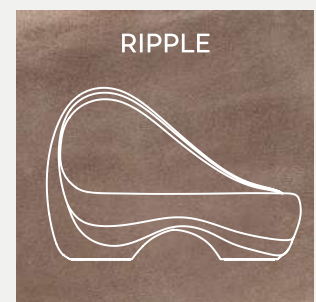
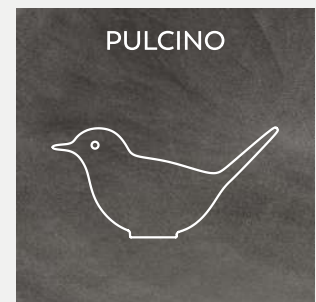
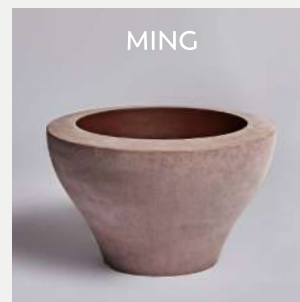
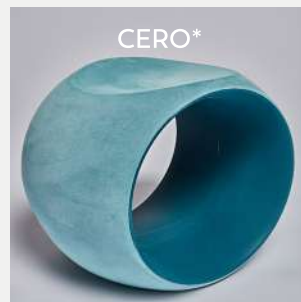

MOLE SKIN

Moleskin



FINITURA ARTIGIANALE SVILUPPATA NEI LABORATORI SERRALUNGA

Moleskin è una lavorazione artigianale che nasce dalla storia di Serralunga e nello specifico dall'esperienza nella lavorazione della pelle.

Con lo spirito di ricerca e innovazione che da sempre caratterizza l'evoluzione dell'azienda, presentiamo con orgoglio alcuni dei nostri prodotti dall'aspetto inedito alla vista e inaspettato al tatto.

Una lavorazione che richiama i preziosi tessuti di fustagno, tessuti robusti, caldi e confortevoli, superfici da toccare e pettinare come un cervo. Con Moleskin, la forza e la qualità dei mobili da esterno Serralunga assumono un'eleganza raffinata ma tradizionale.

MATERIALI E CARATTERISTICHE

- 100% LLDPE riciclabile
- Tecnologia: stampaggio rotazionale
- > 100 % riciclabile
- > Resistente alle temperature
- > Leggero
- > Facile manutenzione - graffi e irregolarità possono essere rimossi utilizzando l'apposita spugna in dotazione
- > Lavabile
- > Colori resistenti ai raggi UV
- > Tempi di asciugatura molto rapidi
- > Design Registrato

ARTISAN FINISH DEVELOPED IN SERRALUNGA WORKSHOPS

The **Moleskin** is a craftsmanship that comes from the history of Serralunga and specifically from the experience in leather processing.

With the spirit of research and innovation that has always characterized the evolution of the company, we proudly present some of our products with an unprecedented appearance to the eye and unexpected to the touch.

A process that recalls the precious Moleskin fabrics, robust, warm and comfortable fabrics, surfaces to touch and comb like a deer. With Moleskin, the strength and quality of Serralunga outdoor furniture take on a refined yet traditional elegance.

MATERIALS AND FEATURES

- 100 % recyclable LLDPE
- Technology: rotational molding
- > 100% recyclable
- > Resistant to temperatures
- > Light
- > Easy maintenance – if irregularities appear on the finish, it will be possible to restore them by gently rubbing the supplied sponge on the affected area
- > Easily washable
- > Colours resistant to the UV rays
- > Very fast drying times
- > Registered Design





*Pine Beach
Juju*

Moleskin



Bay



Sirchester



Lounge Cube

Moleskin





Moleskin



Cero
Juju
Pic-nic



Ming Alto
Ming Basso

Moleskin



Pic-nic



Newpot 60

Moleskin



Sirchester



Aqua



Sirchester

Moleskin



Memory Pot



All colors available



ART



FAITUTTOTU
pag. 34



FLOW
pag. 38



HIC!
pag. 42



HOLLY ALL
pag. 44



KEW
pag. 48



MISSED TREE
pag. 50



NEW_WAVE
pag. 54



RIPPLE
pag. 58



SANTAVASE
pag. 62



THE VASES
pag. 64

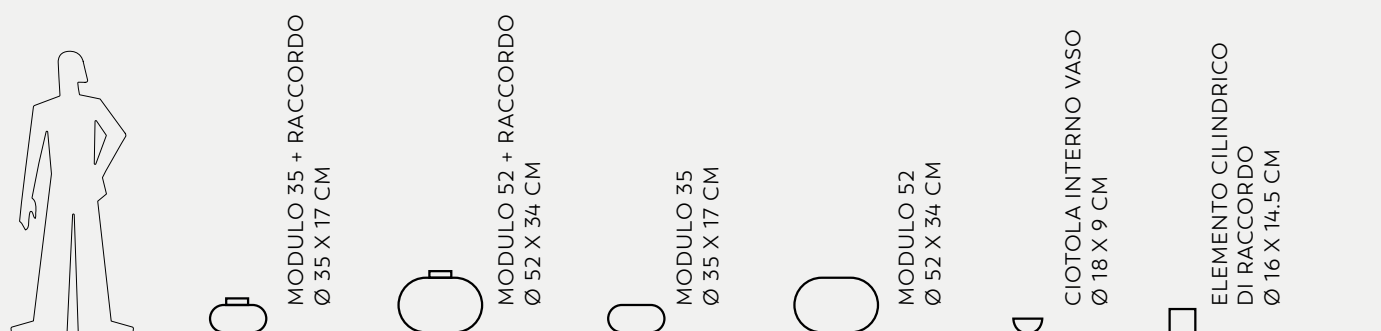

ART

FAITUTTOTU

Sottsass Associati









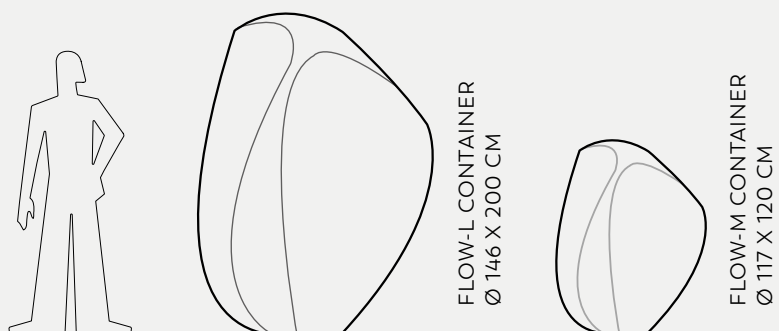

ART

FLOW

Zaha Hadid





Flow L, Limited Edition

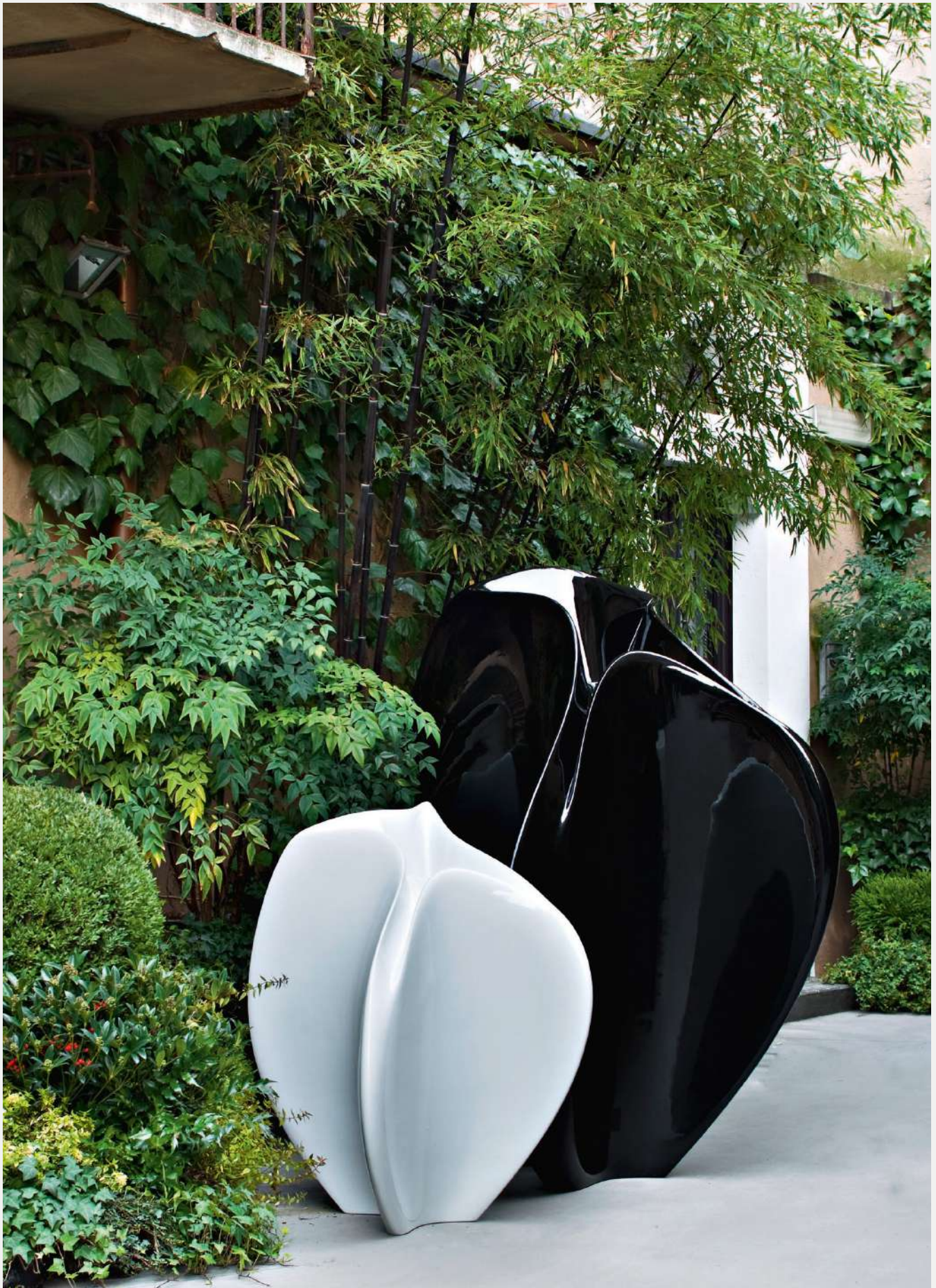

Flow M, Flow L - Lacquered finishing



Flow M, Flow L - Lacquered finishing

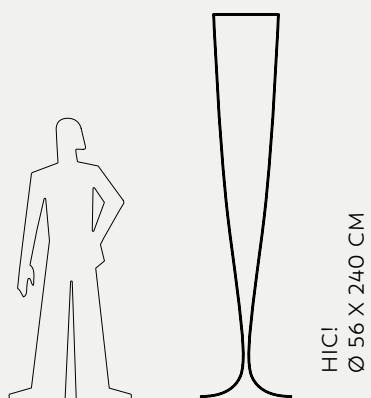

ART

HIC!

Marc Sadler





Hic! — Carbon fiber

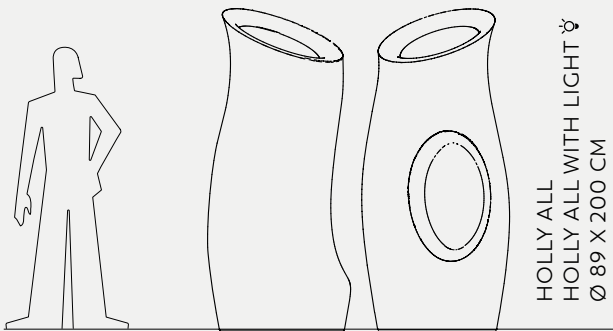

HOLLY ALL
HOLLY ALL WITH LIGHT 
Ø 89 X 200 CM

 AVAILABLE WITH LIGHT

ART

HOLLY ALL

Philippe Starck
Eugeni Quitllet





Holly All



Holly All — Lacquered finishing



Holly All — Lacquered finishing

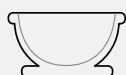
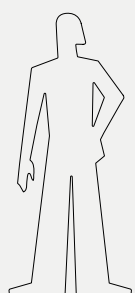

KEW
Ø 73 X 40 CM

ART

KEW

Vico Magistretti





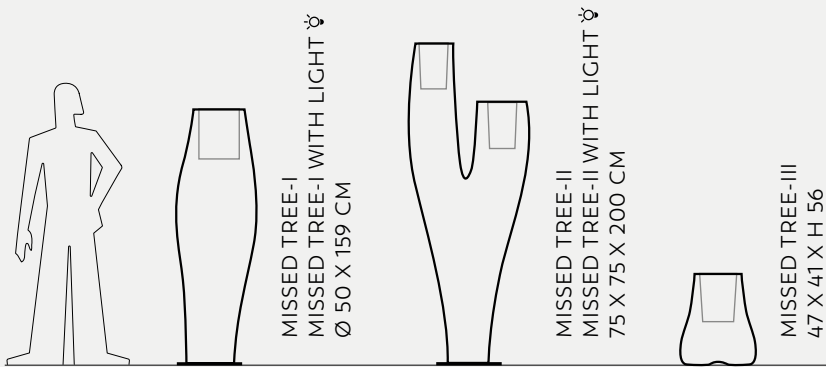

☞ AVAILABLE WITH LIGHT

ART

MISSED TREE

Jean-Marie Massaud





Missed Tree II with light



Missed Tree I, II

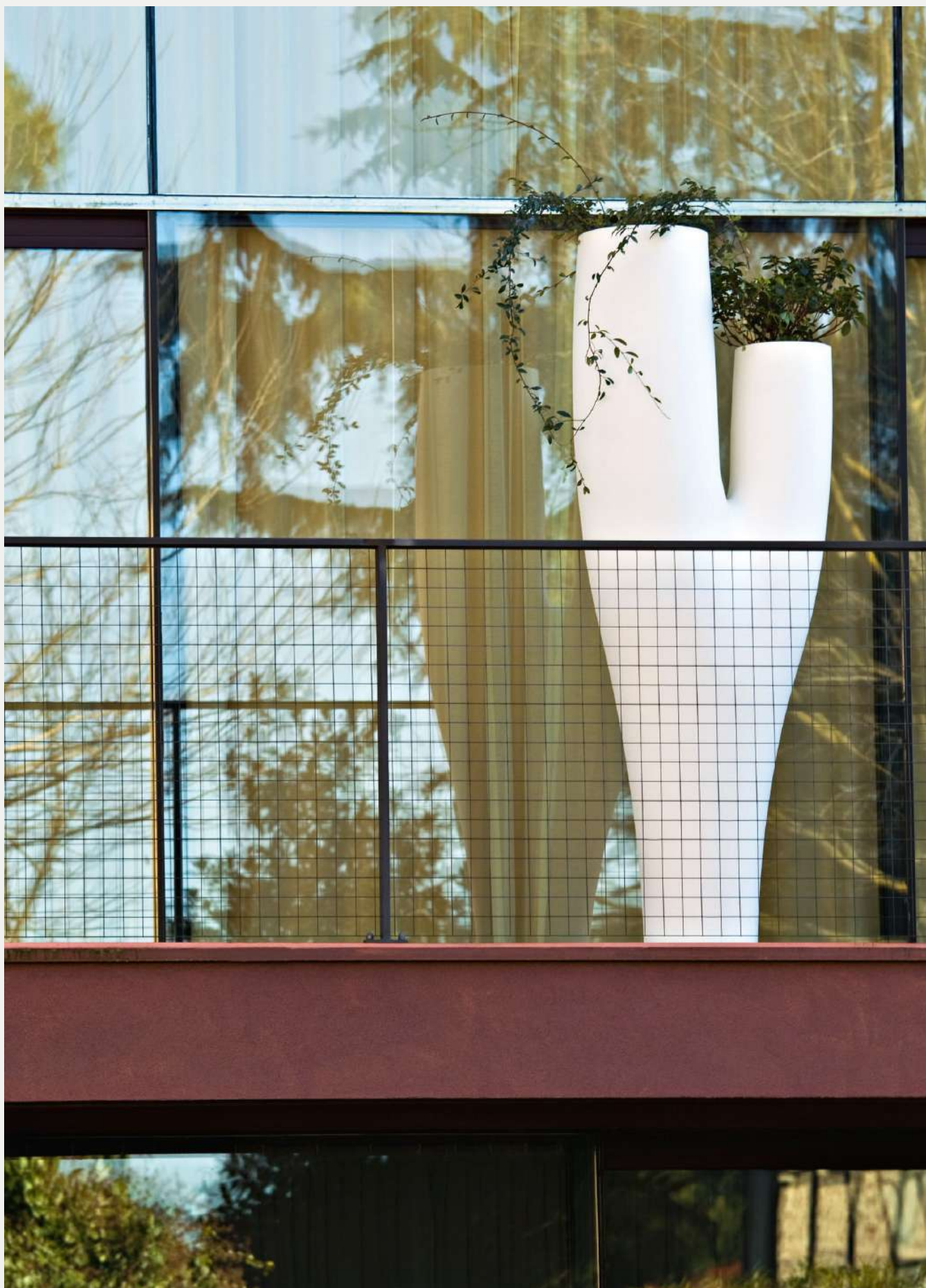

Missed Tree II

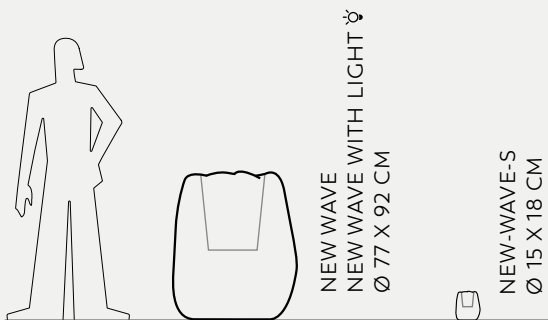

✨ AVAILABLE WITH LIGHT

ART

NEW_WAVE

Ross Lovegrove





New Wave - Lacquered finishing

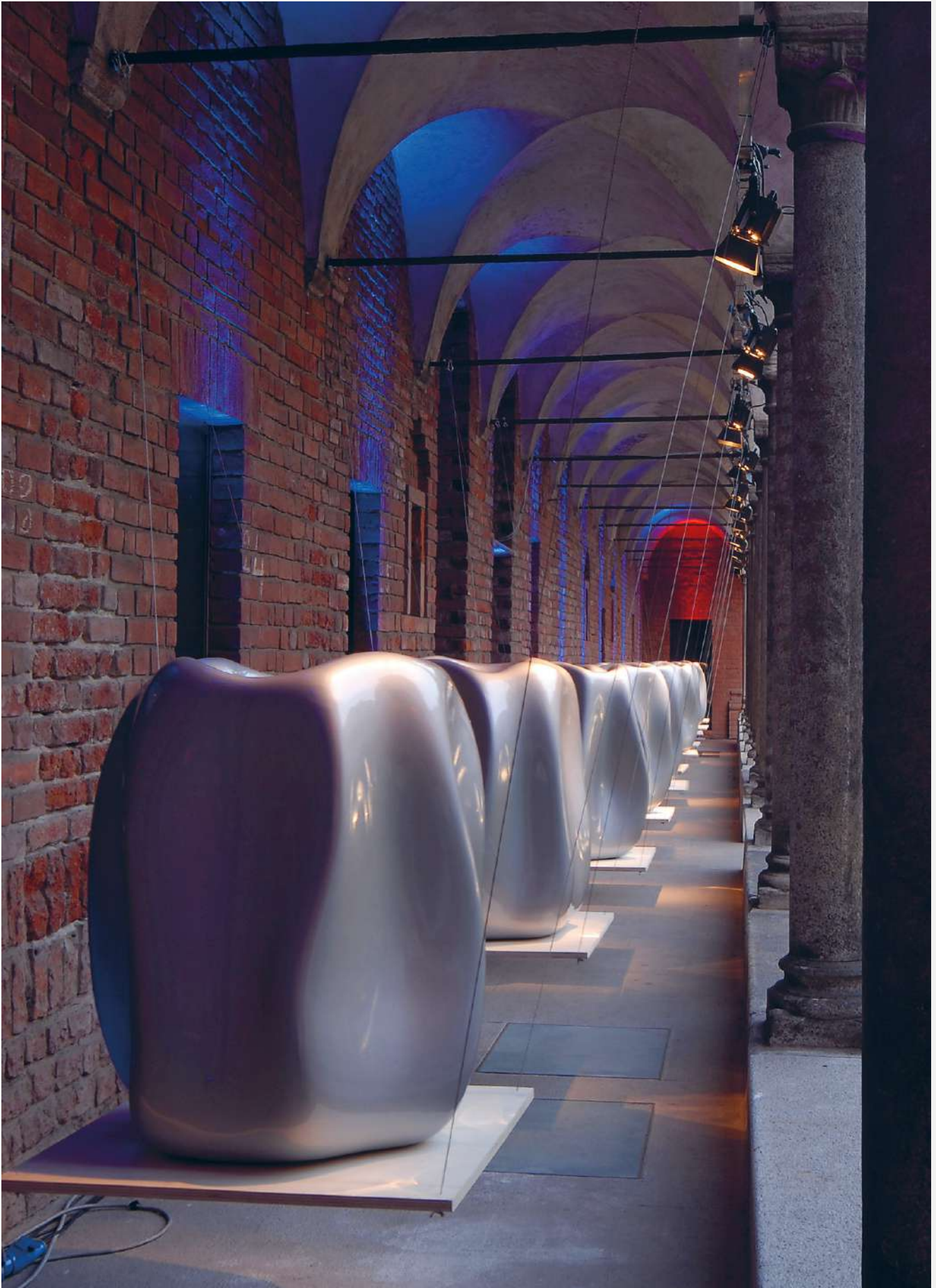

New Wave – Metallic lacquered finishing



New Wave – Lacquered finishing

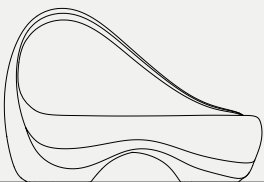
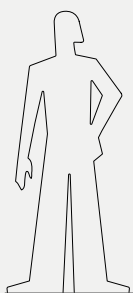

RIPPLE SOFA
152 X 76 X 103 CM

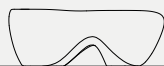

RIPPLE TABLE
92 X 60 X 34 CM

☞ AVAILABLE WITH LIGHT

ART

RIPPLE SOFA' AND TABLE

Zaha Hadid





Ripple Sofa' and Table
Flow-m
Flow-l





*Ripple sofà and Table
Cup
Lampadaria*

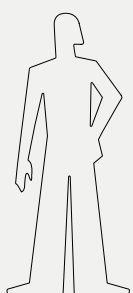

SANTAVASE
40 X 40 X 85 CM

ART

SANTAVASE

Denis Santachiara





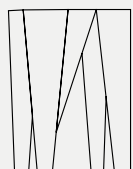
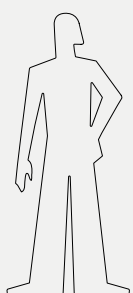

THE VASES
80 X 63 X 110 CM



THE VASES SURFACE

ART

THE VASES

Ron Arad





The Vases



The Vases



The Vases



URBAN FURNITURE



CONE
pag. 70



PRIMAVERA
pag. 72



VAS FAMILY & BIG-BO
pag. 74



VERSAILLES
pag. 82

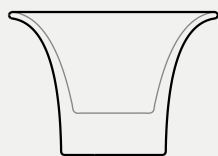

CONE
CONE WITH LIGHT ☼
Ø 130 X 90 CM

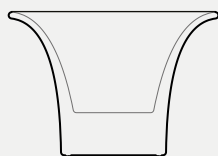

CONE DRINK
CONE DRINK WITH LIGHT ☼
Ø 130 X 90 CM

☼ AVAILABLE WITH LIGHT

URBAN FURNITURE

CONE

Naoto Fukasawa





Cone — Lacquered finishing

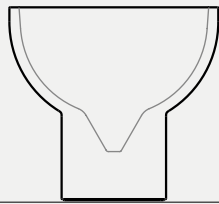
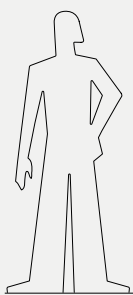

PRIMAVERA
PRIMAVERA WITH LIGHT ✨
Ø 130 X 120 CM

✨ AVAILABLE WITH LIGHT

URBAN FURNITURE

PRIMAVERA

Eero Aarnio





Primavera



THE FIRST AND
ORIGINAL VAS-ONE

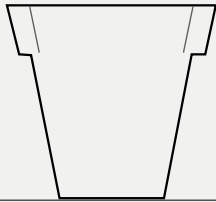
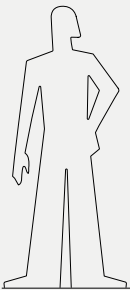

VAS-ONE
VAS-ONE WITH LIGHT ☼
Ø 130 X 120 CM

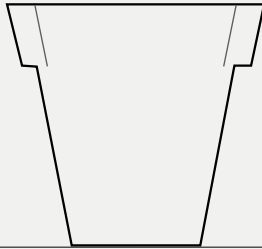

VAS-TWO
VAS-TWO WITH LIGHT ☼
Ø 160 X 150 CM



BIGGEST POT
IN THE WORLD

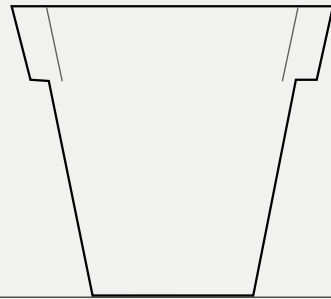

BIG-BO
BIG-BO WITH LIGHT ☼
Ø 200 X 180 CM

☼ AVAILABLE WITH LIGHT

URBAN FURNITURE

VAS FAMILY & BIG-BO

Luisa Bocchietto





Vas-One with light



Hour Collection sofa



*Vas-One and Vas-Two
Crystal Moon Lamp*





Vas-one with light



Vas-One

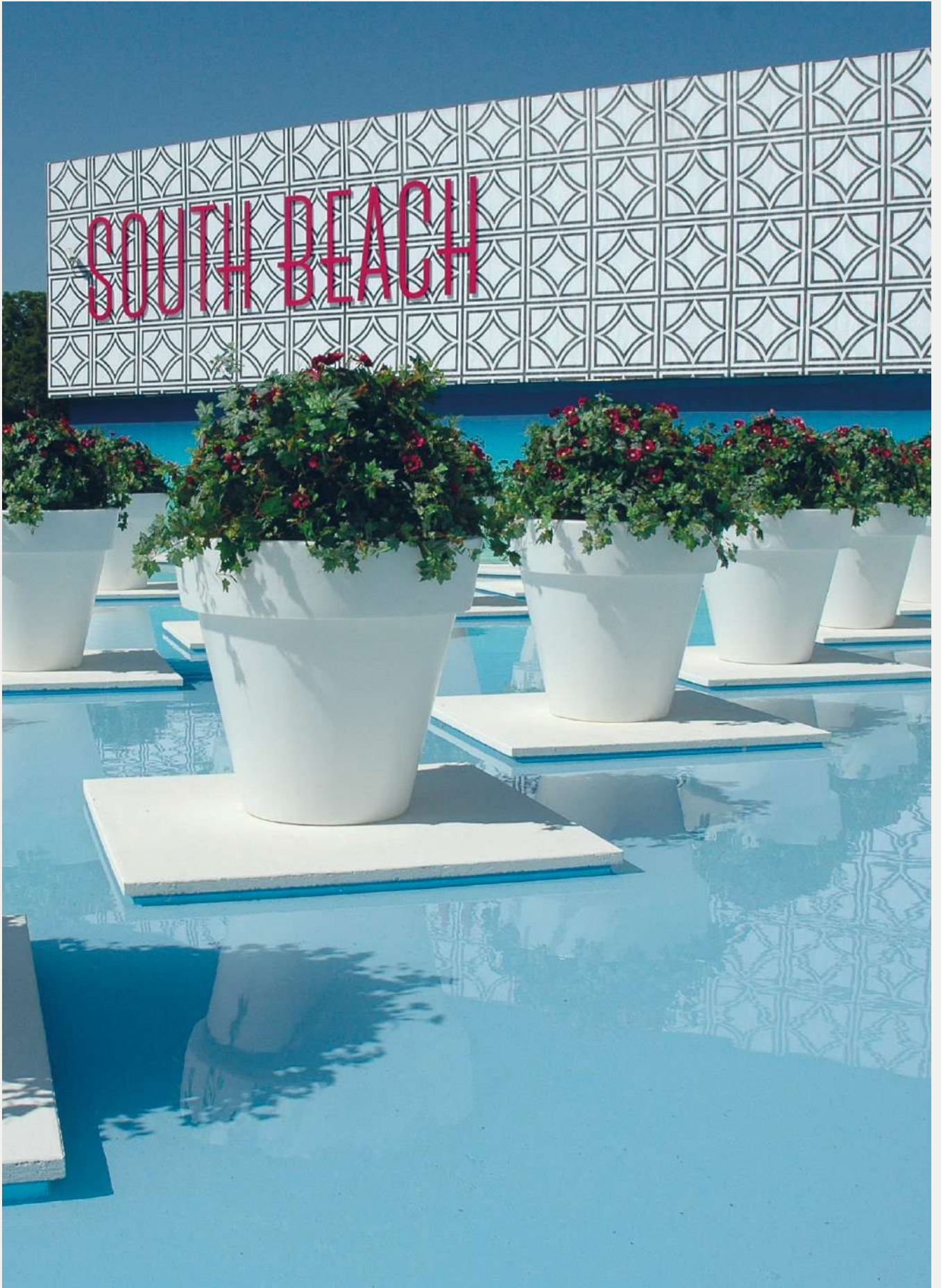

Vas-One

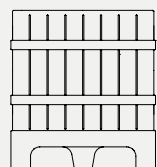
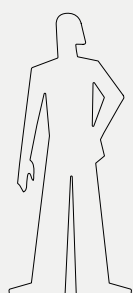

VERSAILLES
90 X 90 X 98 CM



URBAN FURNITURE

VERSAILLES

Serralunga





Versailles





Versailles



POTS



BORDATO LISCIO
pag. 90



CAMELIA
pag. 94



CASSERO
pag. 98



CUBOTTI
pag. 104



CUP
pag. 110



EUFRONIO
pag. 114



FENCE
pag. 118



GRAND JANE
pag. 122



GRAND MARY
pag. 122



GREEN PILLS
pag. 124



INORBITA
pag. 128



JUNE
pag. 130



KABIN
pag. 132



LISCIO SIENA
pag. 136



LLUNA
pag. 140



MARCANTONIO
pag. 142



MEMORY POT
pag. 146



MING
pag. 150



NEOCLASSIC
pag. 156



NEWPOT
pag. 160



PISA
pag. 168



POT AU MUR
pag. 172



SCARLETT
pag. 174



SEVRES
pag. 176



TORRE
pag. 180



TUBINI
pag. 184



UOVO DI COLOMBO
pag. 186



VAS-THREE
pag. 406 (see Lights)



**VASO RETTANGOLARE
O/E**
pag. 188

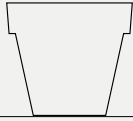
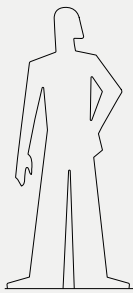

618
618 WITH LIGHT ☼
78 X 78 X 70 CM

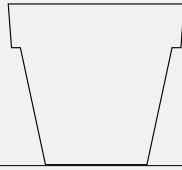

619
619 WITH LIGHT ☼
110 X 110 X 100 CM

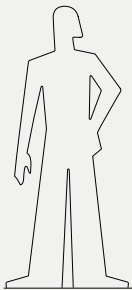

614
35,5 X 35,5 X 31 CM



615
46 X 46 X 40 CM

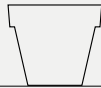

616
616 WITH LIGHT ☼
58 X 58 X 50 CM

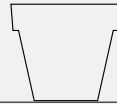

617
617 WITH LIGHT ☼
68 X 68 X 60 CM

☼ AVAILABLE WITH LIGHT



SCRATCHED SURFACE

POTS

BORDATO LISCIO

Serralunga





Bordato Liscio - Finishing detail

SERRALUNGA
1825



Bordato Liscio



Bordato Liscio

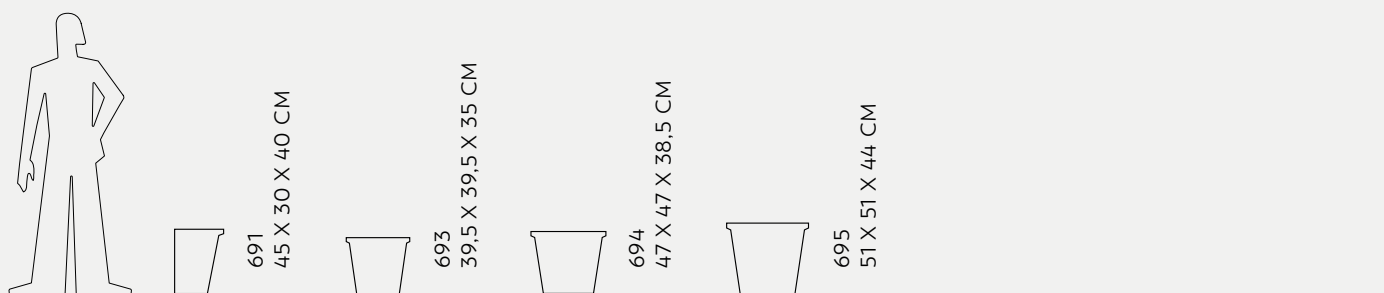
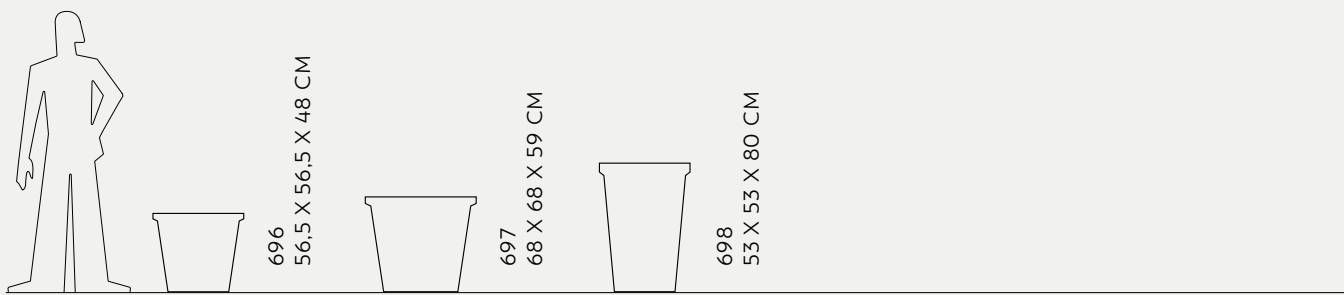

 SCRATCHED SURFACE

POTS

CAMELIA

Serralunga





Camelia collection



Camelia



Camelia

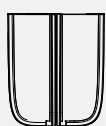
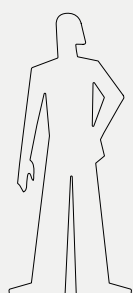

CASSERO 60
60 X 60 X 70 CM



CASSERO LONG
100 X 48 X 55 CM



CASSERO SLIM
30 X 83 X 72.5 CM



CASSERO SURFACE

POTS

CASSERO

Patricia Urquiola







*Cassero
Bordato liscio*



Cassero





*Cassero Slim
Croisette Chairs
Lou Lou slim Table*

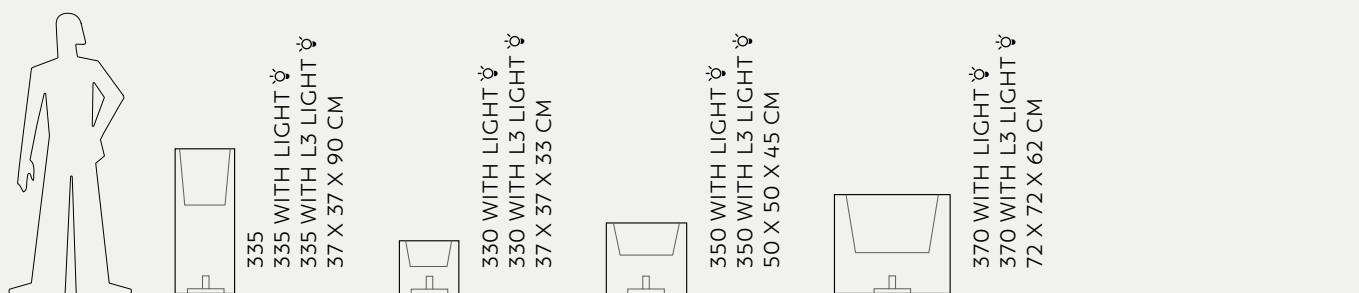
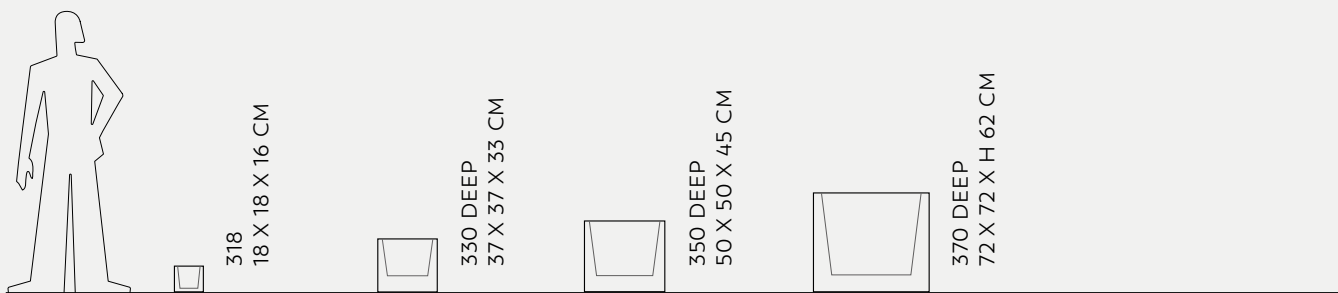

☼ AVAILABLE WITH LIGHT

POTS

CUBOTTI

Nat Wave





Cubotti light 3 — Lacquered finishing





Cubotti — Standard finishing



Cubotti Light



Cubotti Light

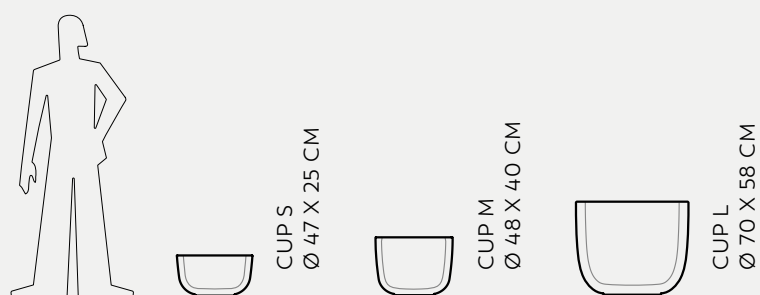

POTS

CUP

Naoto Fukasawa





Bay corten finishing
Cup corten finishing



Cup



Cup

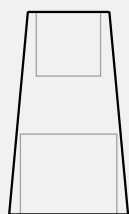
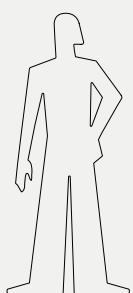

EUFRONIO
Ø 74 X 126 CM

POTS

EUFRONIO

Paolo Rizzatto







Eufronio



Eufonio

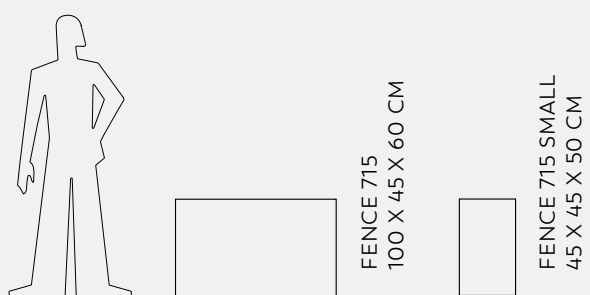

POTS

FENCE

Raffaella Mangiarotti





Fence 715 Small





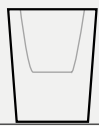
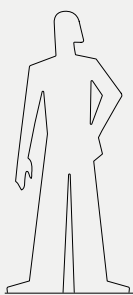

GRAND JANE
GRAND JANE WITH LIGHT ✨
Ø 55 X 70 CM



GRAND MARY
GRAND MARY WITH LIGHT ✨
Ø 70 X 70 CM

✨ AVAILABLE WITH LIGHT

POTS

GRAND JANE / GRAND MARY

Marc Sadler





Grand Jane - Lacquered finishing with light



Grand Mary - Lacquered finishing with light

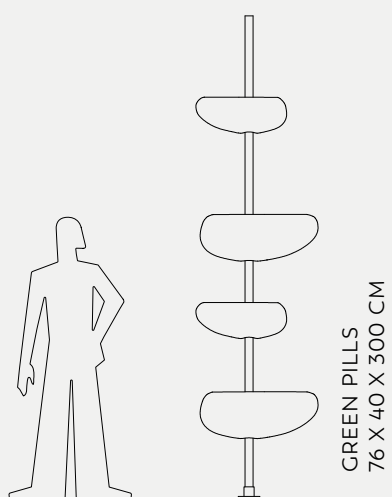

POTS

GREEN PILLS

ZPZ Partners







Green Pills



Green Pills

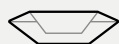
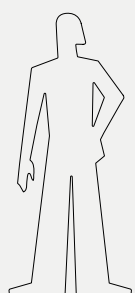

INORBITA
Ø 68 X 20 CM

POTS

INORBITA

Alberto Meda





Inorbita

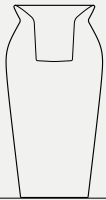
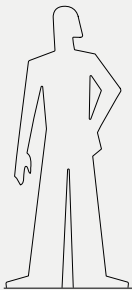

JUNE WITH LIGHT ☼
JUNE HL
JUNE HL
Ø 60 X 120 CM

☼ AVAILABLE WITH LIGHT

POTS

JUNE

Christophe Pillet





June HL with Light

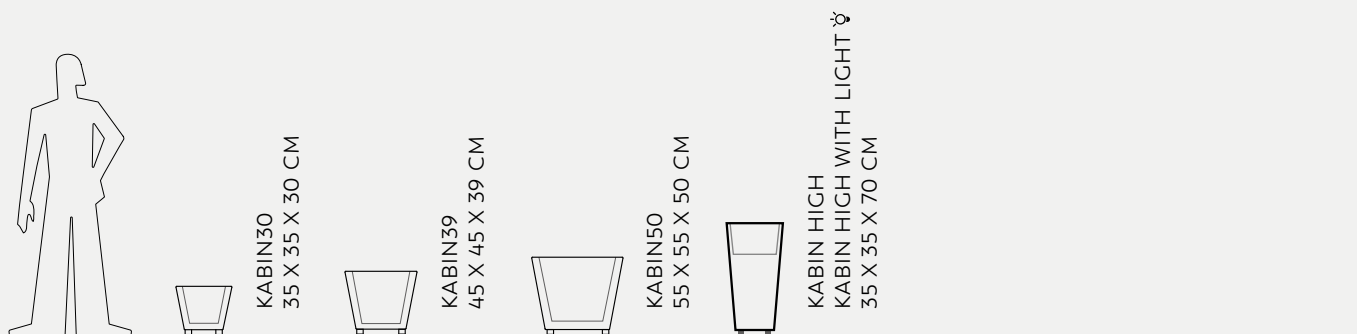
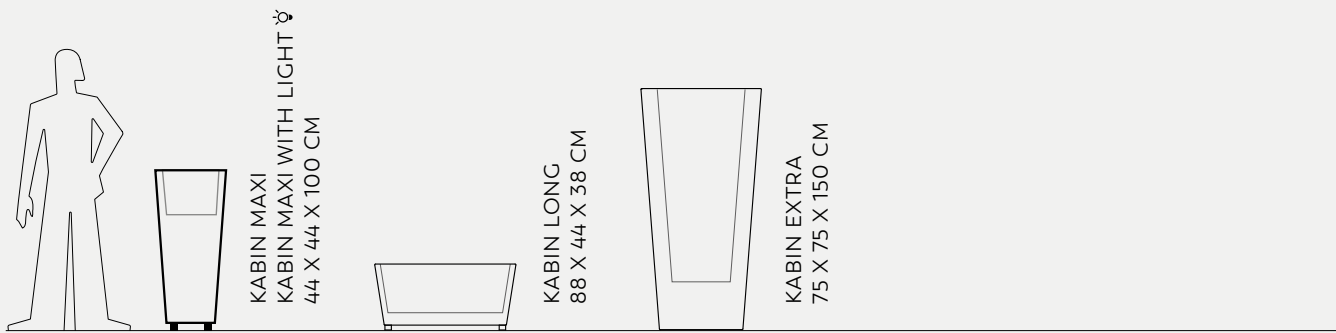

☼ AVAILABLE WITH LIGHT

POTS

KABIN

Luisa Bocchietto





Kabin Maxi — Lacquered finishing



Kabin Long

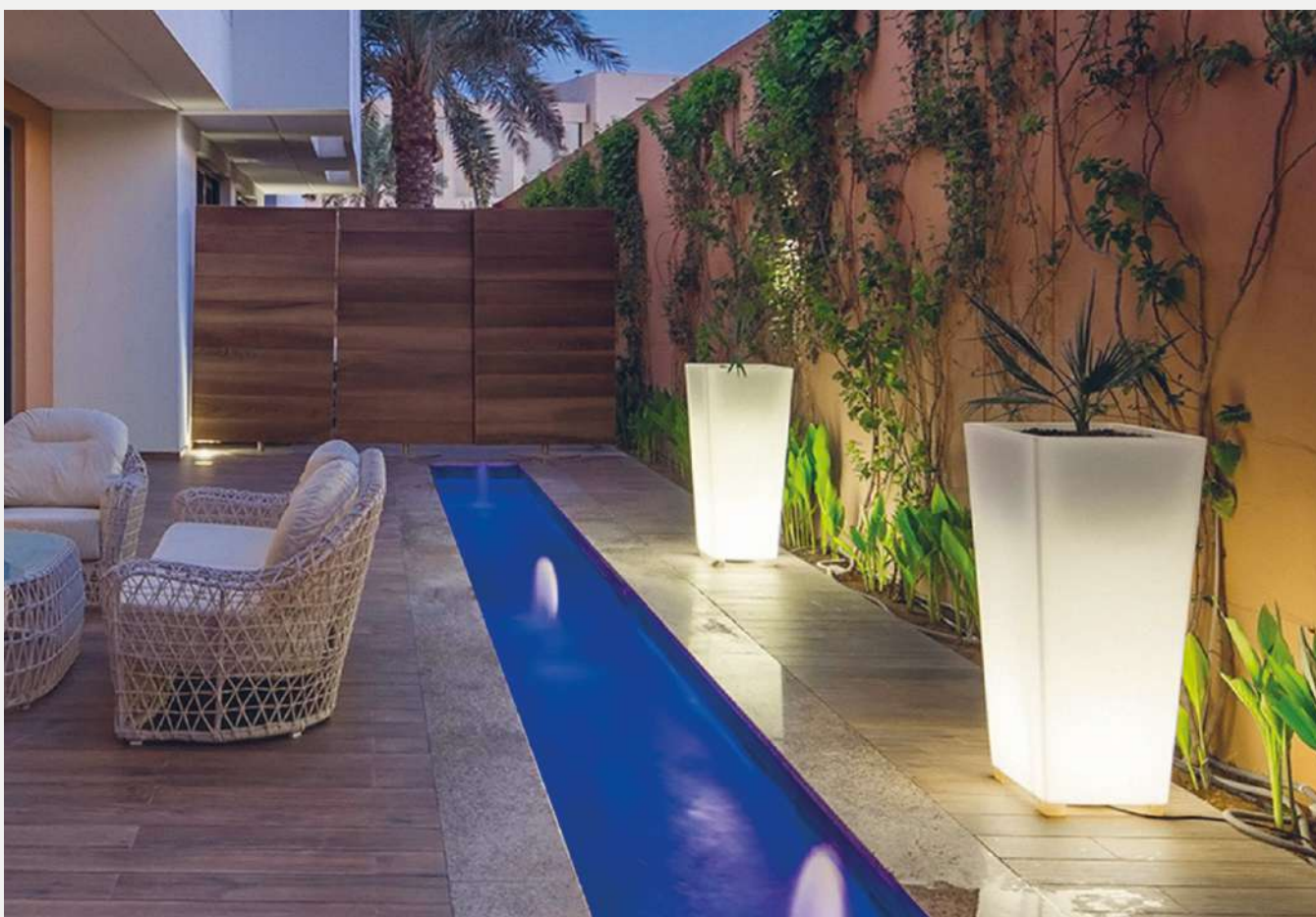

Kabin Maxi with light

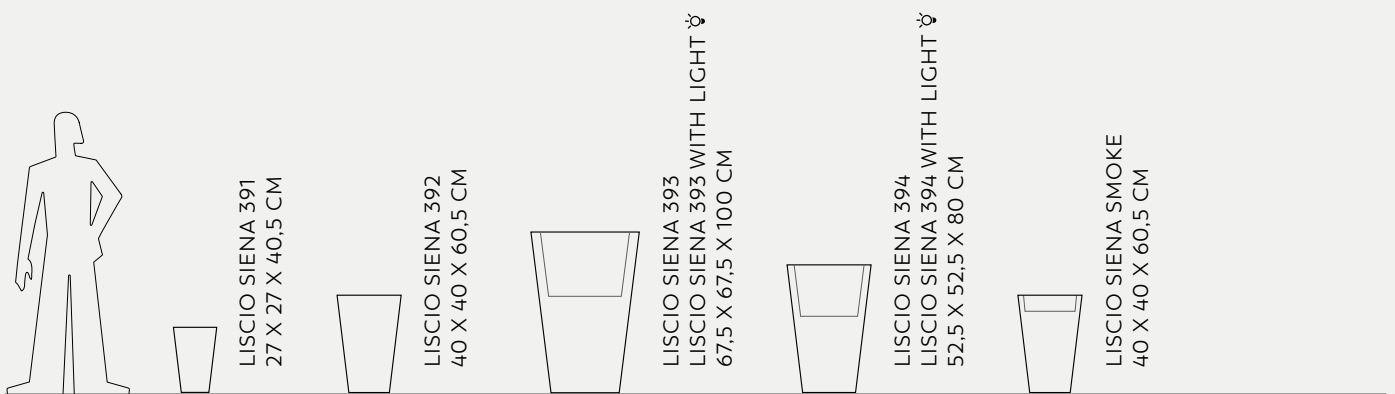

☼ AVAILABLE WITH LIGHT

 SCRATCHED SURFACE

POTS

LISCIO SIENA

Serralunga





Liscio Siena finishing detail



Liscio Siena with light



Liscio Siena 391, 392 and 393

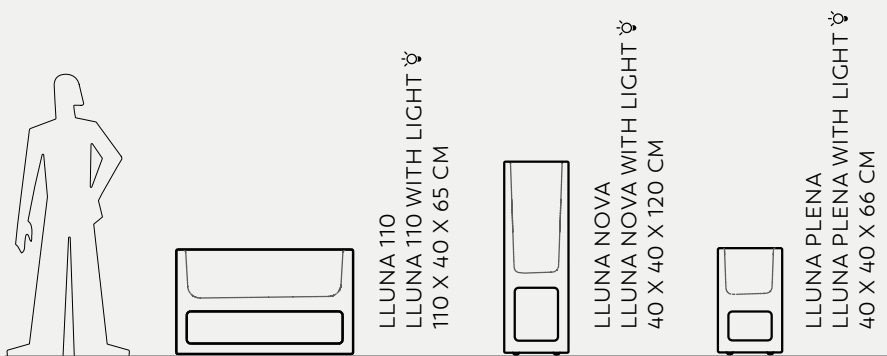

☽ AVAILABLE WITH LIGHT

POTS

LLUNA

Joan Gaspar







Lluna Nova

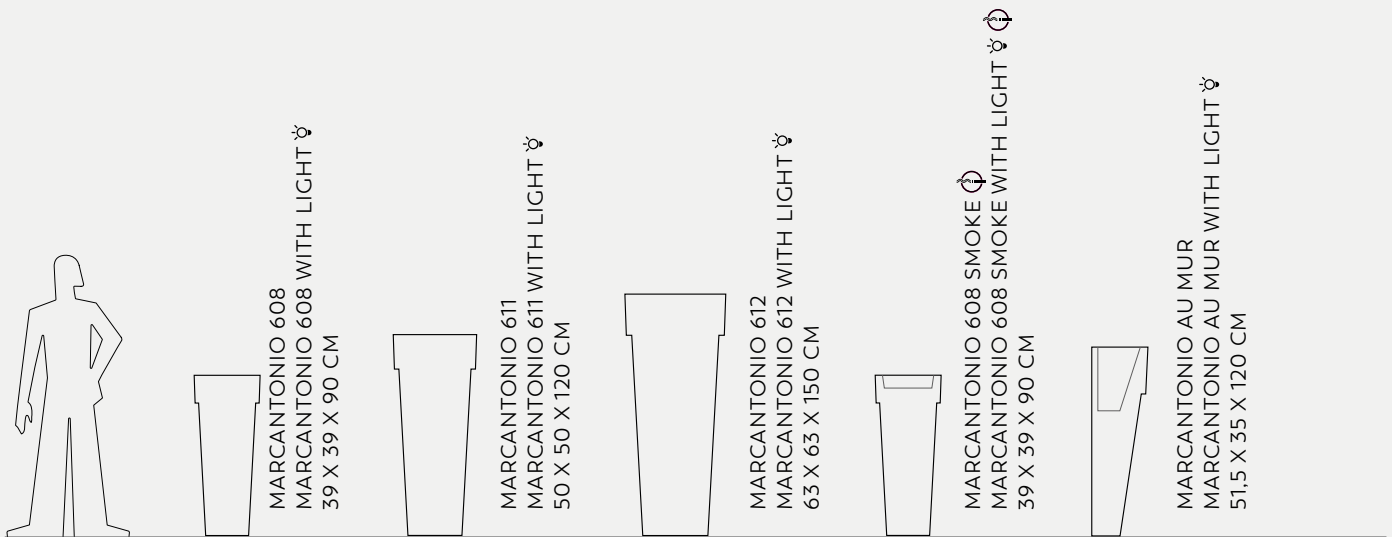

Lluna 110 with light



 MOLESKIN FINISHING AVAILABLE

☼ AVAILABLE WITH LIGHT

POTS

MARCANTONIO

Serralunga





Marcantonio with light



Marcantonio Au Mur



Marcantonio ashtray

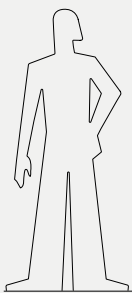

MEMORY POT 301
MEMORY POT 301 WITH LIGHT ☼
49/52 X 49/52 X 43 CM



MEMORY POT 302
MEMORY POT 302 WITH LIGHT ☼
57/66 X 57/66 X 77.5 CM

POTS

MEMORY POT

Marta Daza Fernandez

☼ AVAILABLE WITH LIGHT



MEMORY POT SURFACE



MOLESKIN FINISHING AVAILABLE





Memory Pot Moleskin Finishing



Memory Pot with light



Memory Pot

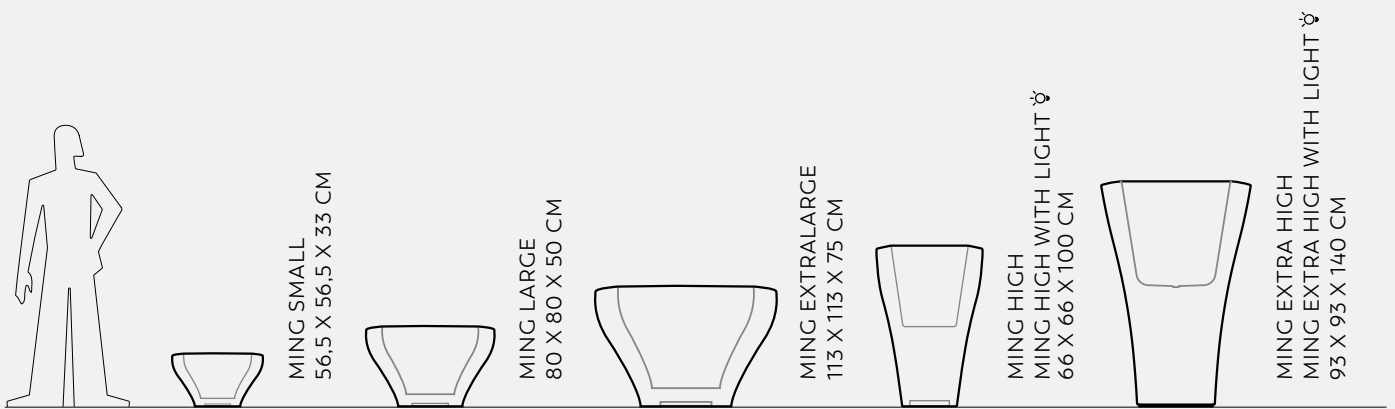

MOLESKIN FINISHING AVAILABLE

☞ AVAILABLE WITH LIGHT

POTS

MING

Rodolfo Dordoni





Ming Large



Ming Large and High



Ming High and Extra High with light



Ming High – Lacquered finishing

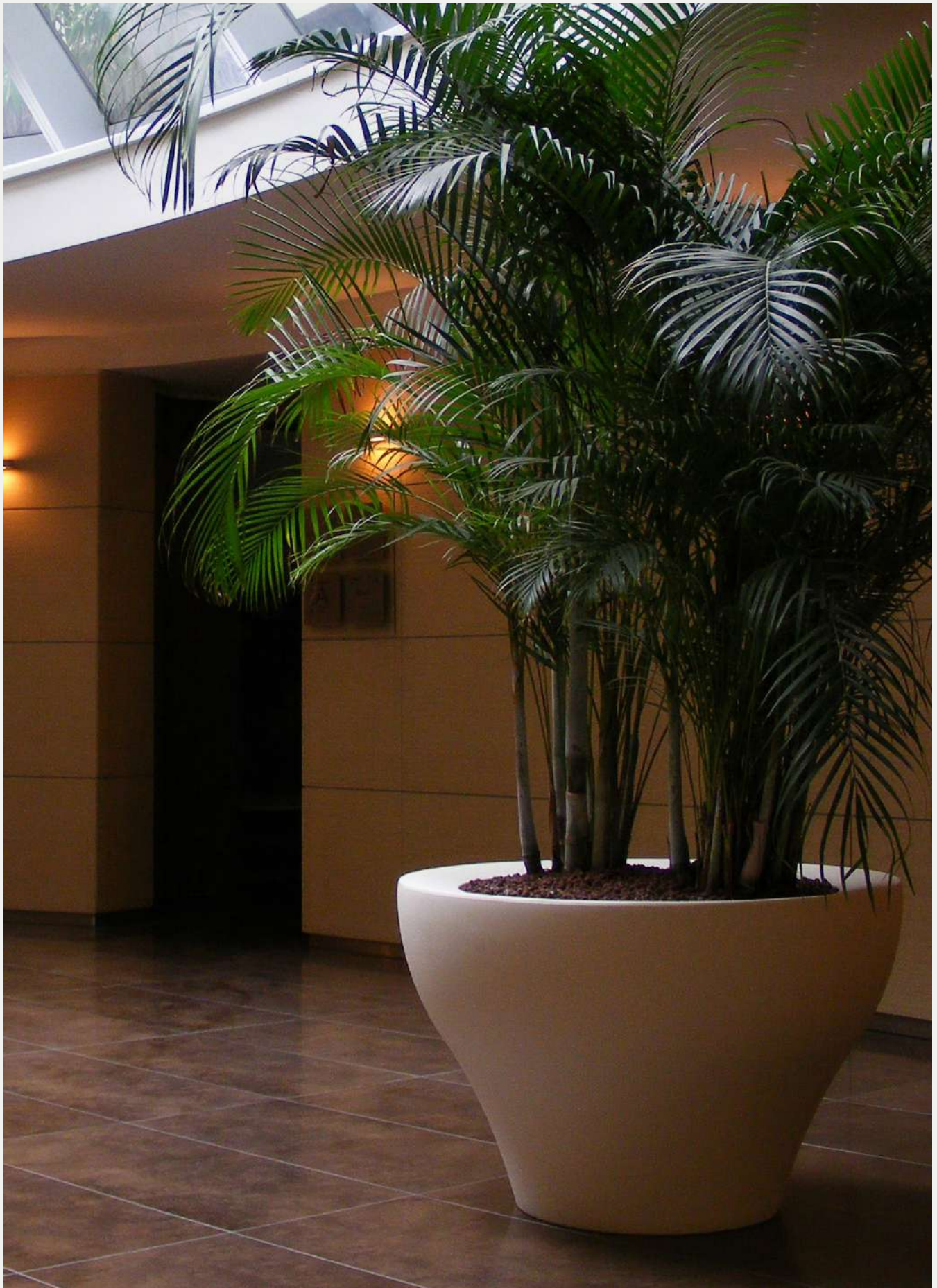

Ming Large



Ming High - Ming Large - Ming Extra High

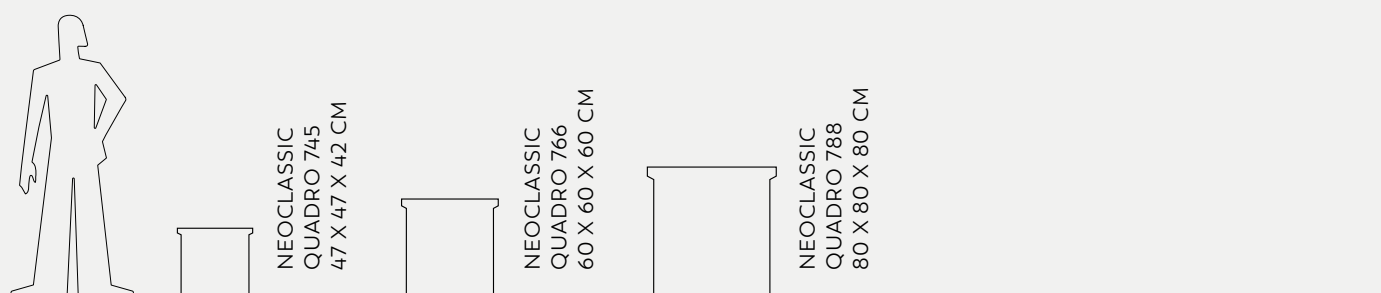
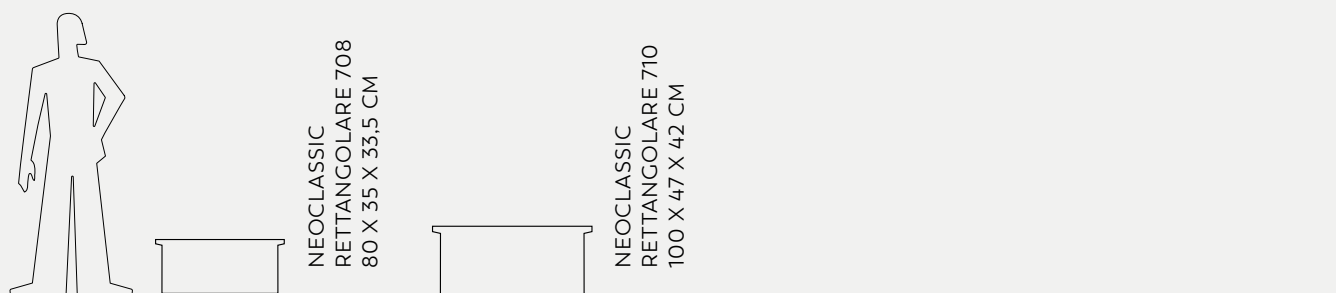

POTS

NEOCLASSIC

Serralunga





Neoclassic Quadro Liscio





Neoclassic Cassetta Liscia

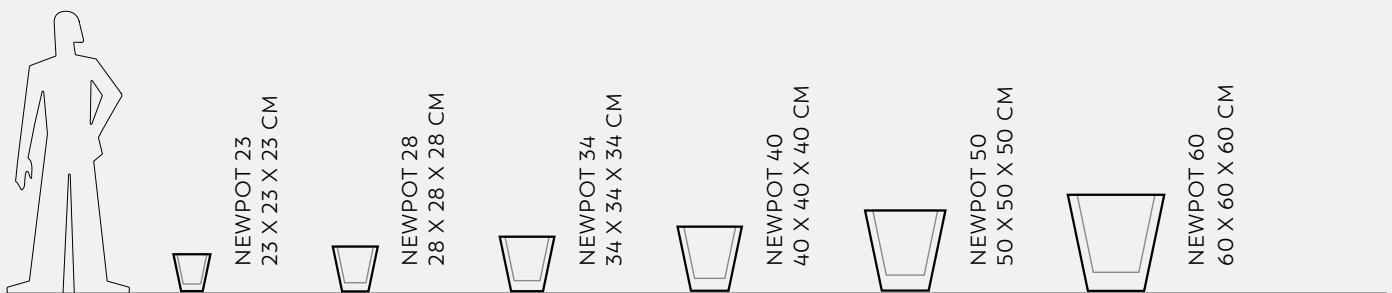
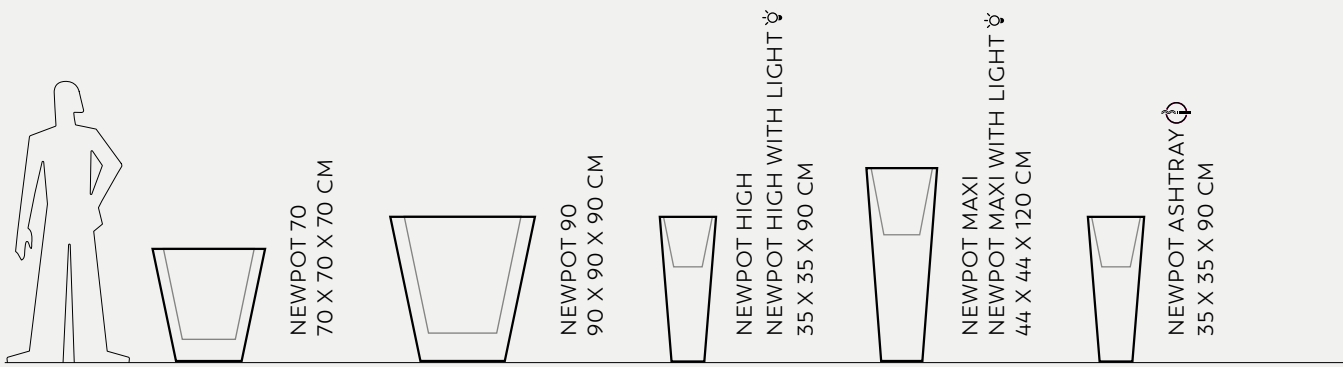

POTS

NEWPOT

Paolo Rizzatto

☞ AVAILABLE WITH LIGHT
 MOLESKIN FINISHING AVAILABLE





Newpot High and Maxi with light



Newpot collection



Newpot collection



Newpot Maxi



Newpot - Corten finishing





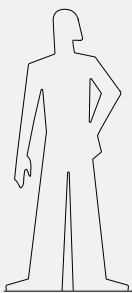

PISA
51 X 51 X 58 CM

POTS

PISA

Denis Santachiara





Pisa





Pisa

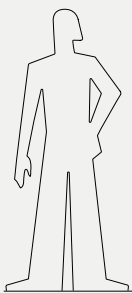

POT AU MUR
47,5 X 47,5 X 90 CM

POTS

POT AU MUR

Ecal / Nicolas Le Moigne





Pot Au Mur

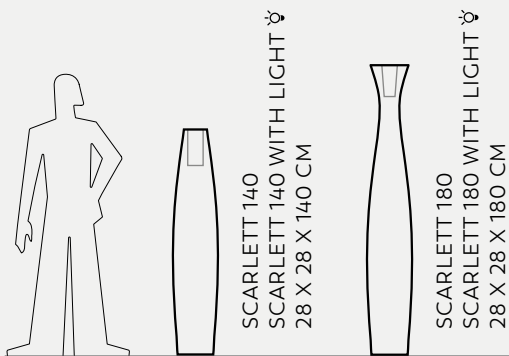

☞ AVAILABLE WITH LIGHT

POTS

SCARLETT

Christophe Pillet





Scarlett 180
One Sofa
One Pouf

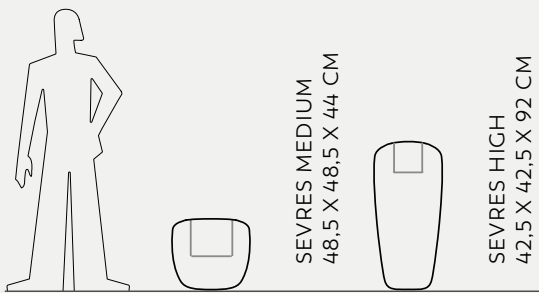

POTS

SEVRES

Rodolfo Dordoni





Sevres Medium and Sevres High



Sevres High



Sevres Medium — Lacquered finishing

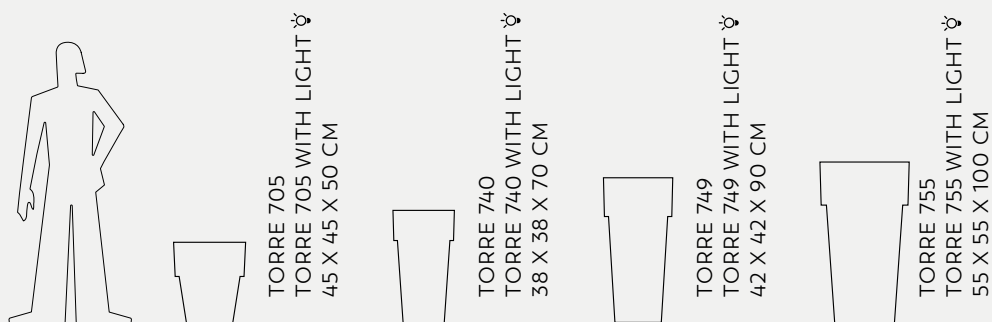

☼ AVAILABLE WITH LIGHT

POTS

TORRE

Serralunga





Torre 705 and 740



Torre 749 and 705 with light

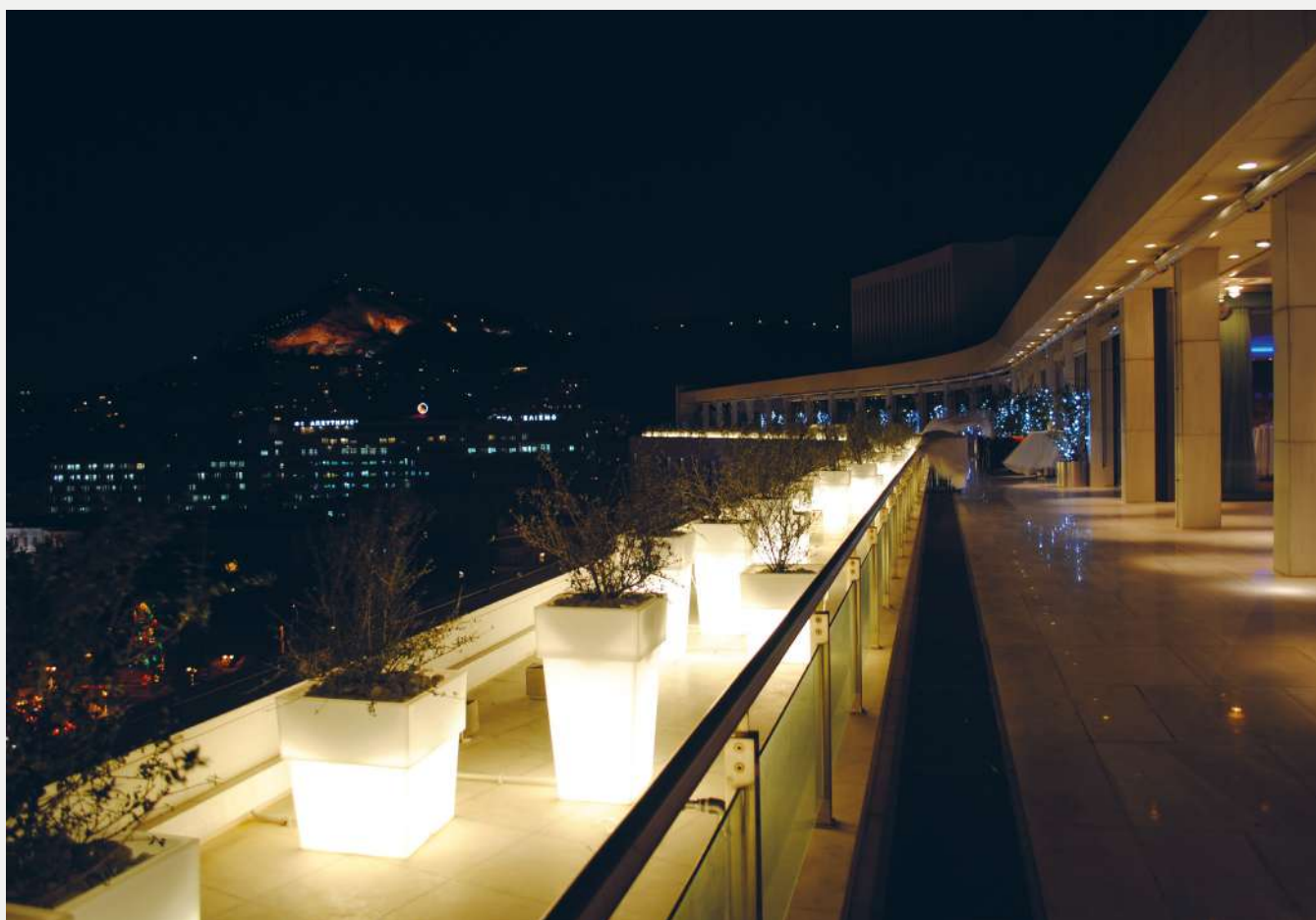

Torre with light collection

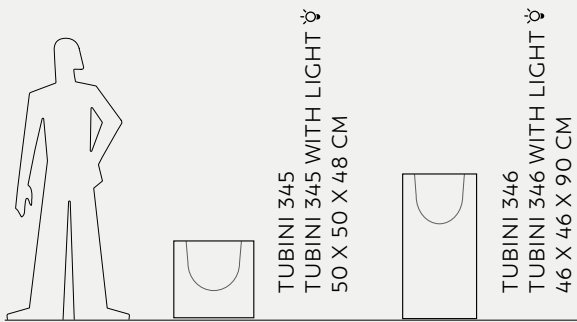

☼ AVAILABLE WITH LIGHT

POTS

TUBINI

Nat Wave





Tubini collection with light

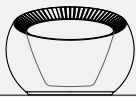
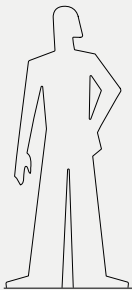

UOVO DI COLOMBO
UOVO DI COLOMBO WITH LIGHT ✨
Ø 80 X 55 CM

✨ AVAILABLE WITH LIGHT

POTS

UOVO DI COLOMBO

Carlo Colombo





Uovo di Colombo

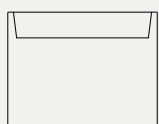
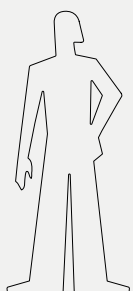

VASO RETTANGOLARE O/E 722
VASO RETTANGOLARE O/E 722 WITH LIGHT ✨
VASO RETTANGOLARE O/E 722/L3 ✨
93,5 X 26,5 X 70 CM

✨ AVAILABLE WITH LIGHT

POTS

VASO RETTANGOLARE O/E

Serralunga





Vaso Rettangolare O/E 722-L3 with light



Torre
Fence 715 Small

Vaso Rettangolare O/E 722
Cubotti 330 Deep



Vaso Rettangolare O/E 722 with light



ARMCHAIRS & SOFAS

ARMCHAIRS >



BAY
pag. 194



CANISSE ARMCHAIR
pag. 202



DOLCEVITA
pag. 208



PINE BEACH ARMCHAIR
pag. 218



SIRCHESTER ARMCHAIR
pag. 224



TIMEOUT
pag. 230

SOFAS >



BELLE ÉTOILE
pag. 200



CANISSE SOFA
pag. 206



HOURL
pag. 210



ONE SLIM
pag. 216



PINE BEACH SOFA
pag. 226



SIRCHESTER SOFA
pag. 232



RIPPLE SOFA
pag. 58 (see Art)

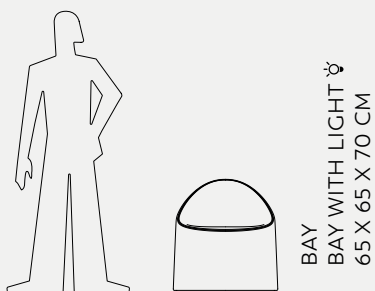

BAY
BAY WITH LIGHT ☼
65 X 65 X 70 CM

ARMCHAIRS & SOFAS

BAY

Raffaella Mangiarotti



MOLESKIN FINISHING AVAILABLE

☼ AVAILABLE WITH LIGHT





*Bay Lounge chair
Juju table
Kentia*



Bay Lounge Chair



Juju Table
Kentia



Bay Lounge Chair – Moleskin finishing



Bay Lounge Chair - Moleskin finishing

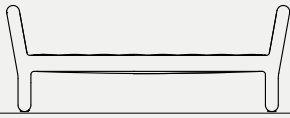
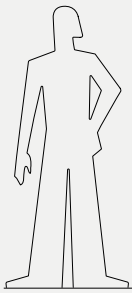

BELLE ÉTOILE
192 X 70 X 74 CM

ARMCHAIRS & SOFAS

BELLE ÉTOILE

Andrée Putman





Belle Étoile
Lou Lou 34

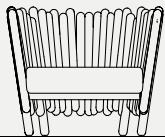
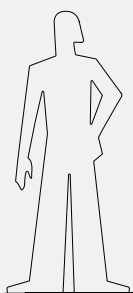

CANISSE ARMCHAIR
97 X 88 X 80 CM

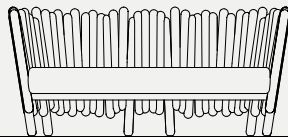

CANISSE SOFA
175 X 88 X 80 CM

ARMCHAIRS & SOFAS

CANISSE

Philippe Nigro





*Canisse Armchair
One Table
One Sofa*



*Canisse Sofa and armchair
Lou Lou tables*



*Canisse sofa
Lou Lou table*





Canisse Armchair

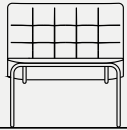
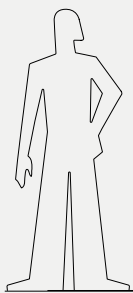

DOLCEVITA ARMCHAIR
77 X 72 X 77 CM

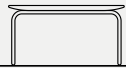

DOLCEVITA POUFF
49 X 72 X 37 CM

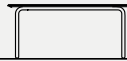

DOLCEVITA TABLE
77,5 X 55 X 33 CM

ARMCHAIRS & SOFAS

DOLCEVITA

Serralunga





Dolcevita and Dolcevita table

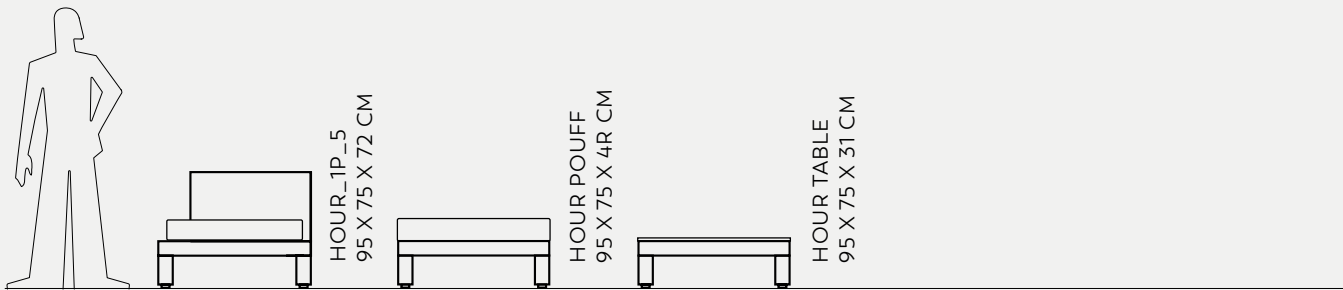
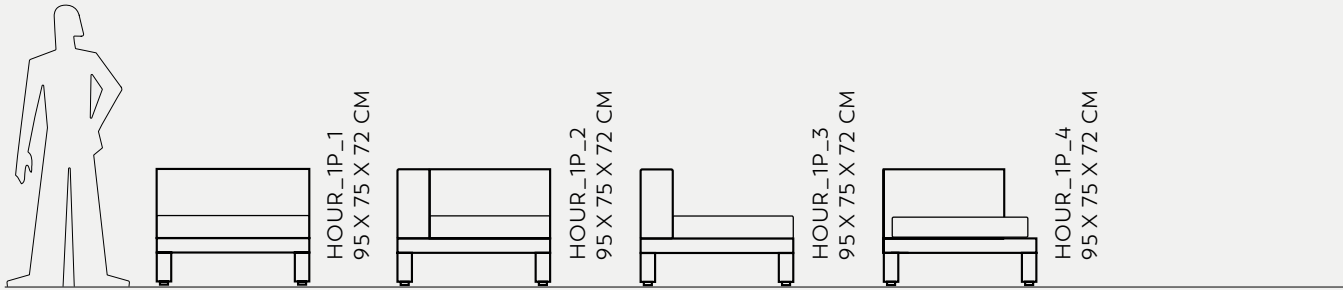

ARMCHAIRS & SOFAS



HOUR

Claudio Bellini





Vas-One
Crystal Moon Lamp

Hour sofa



Hour sofa
Ming Large







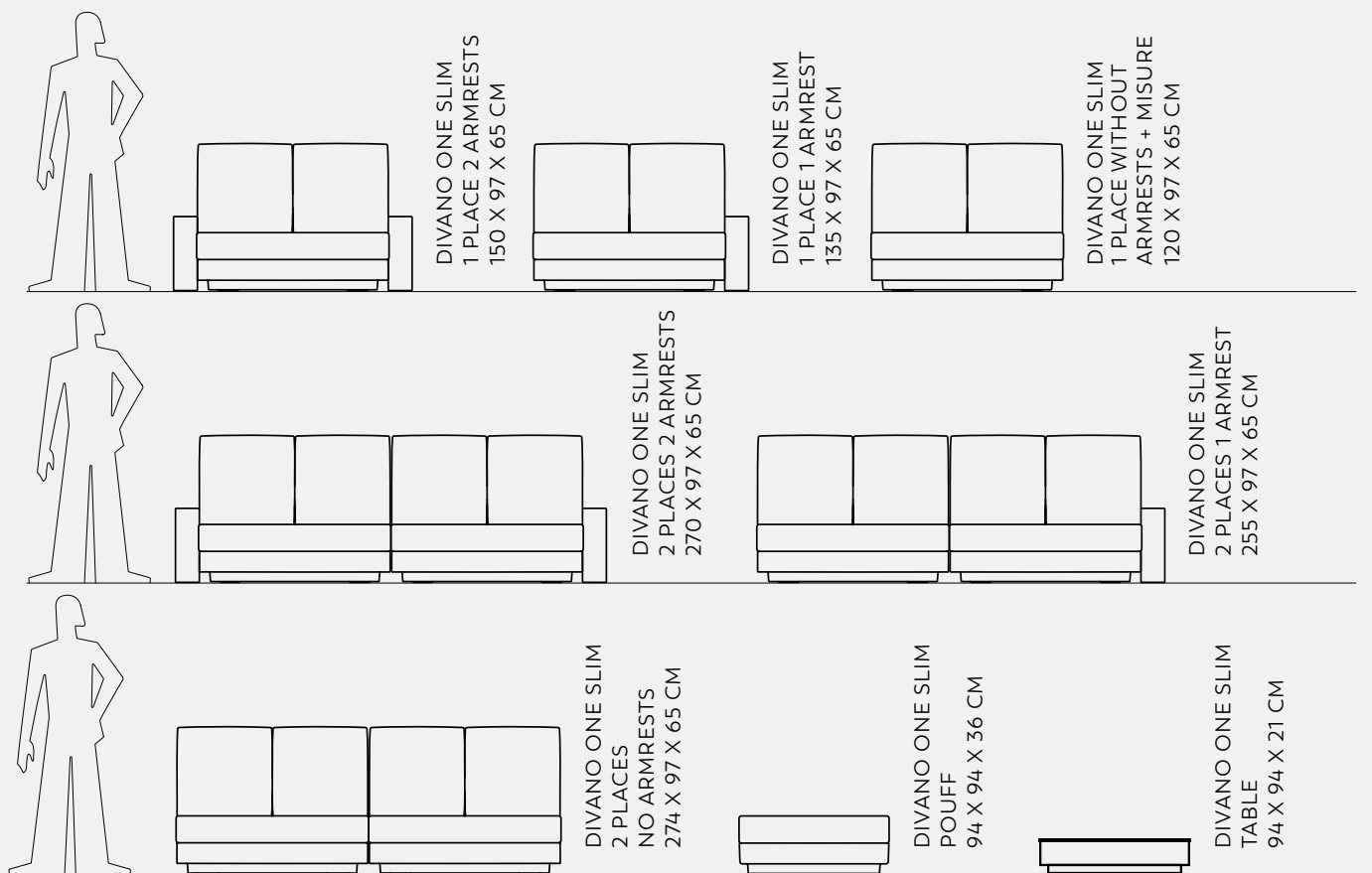

ARMCHAIRS & SOFAS

ONE SLIM

Marc Sadler





One Slim Sofa

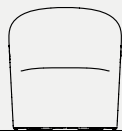
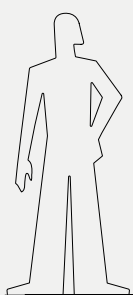

PINE BEACH ARMCHAIR
PINE BEACH ARMCHAIR WITH LIGHT ✂
70 X 66 X 76 CM

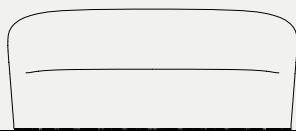

PINE BEACH SOFA
PINE BEACH SOFA WITH LIGHT ✂
180 X 81 X 76 CM



MOLESKIN FINISHING AVAILABLE

✂ AVAILABLE WITH LIGHT

ARMCHAIRS & SOFAS

PINE BEACH

Christophe Pillet





*Pine Beach armchair
Juju table*



*Pine Beach Sofa - Moleskin finishing
Juju - Moleskin finishing*



*Pinebeach armchair and sofa Moleskin Finishing
Juju Table Moleskin Finishing*





*Pine Beach Sofa and Armchair
Juju table*

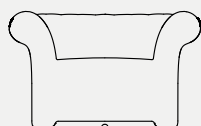
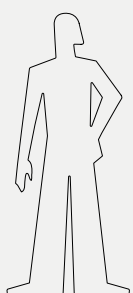

SIRCHESTER ARMCHAIR
SIRCHESTER ARMCHAIR WITH LIGHT ✂
120 X 82 X 72 CM

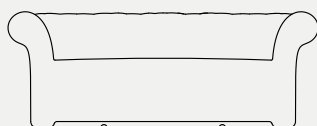

SIRCHESTER SOFA
SIRCHESTER SOFA WITH LIGHT ✂
193 X 82 X 72 CM



MOLESKIN FINISHING AVAILABLE

✂ AVAILABLE WITH LIGHT

ARMCHAIRS & SOFAS

SIRCHESTER

Bazzicalupo / Mangiarotti





Sirchester armchair – Moleskin finishing





Sirchester Sofa
Meteor M/L Lacquered finishing
Lady Jane



Sirchester armchair with light



*Sirchester armchair and Sofa
Meteor coffee table
Newpot 12*



TIME OUT ARMCHAIR
75 X 65 X 74 CM

TIME OUT POUFF
54 X 65 X 36 CM

ARMCHAIRS & SOFAS

TIMEOUT

Rodolfo Dordoni





Time Out armchair
Hour sofa
One table



CHAIRS



CROISSETTE ARMCHAIR
pag. 234



CROISSETTE CHAIR
pag. 234



KUBRICK
pag. 240



REGISTA
pag. 242



RUSSEL
pag. 246



SOLEA
pag. 250

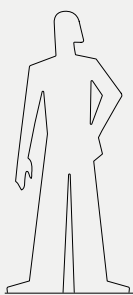

CROISSETTE WITHOUT ARMRESTS
52,8 X 50,3 X 77,8 CM



CROISSETTE WITH ARMRESTS
59,8 X 50,3 X 77,8 CM

CHAIRS

CROISSETTE

Florent Coirier





*Croisette chair
Lindos light - Moleskin finishing
Duetto*



Eufronio pot



*Croisette chair
LouLou table*



Croisette chair



LouLou 70 Slim
Cassero Pot

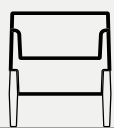
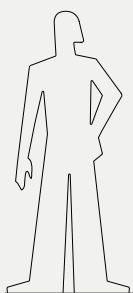

KUBRICK
64 X 62 X 72 CM

CHAIRS

KUBRICK

Marc Sadler





*Kubrick armchair
Pelenquera table*

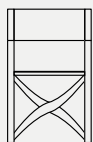

REGISTA
52 X 44 X 83 CM

CHAIRS

REGISTA

Michel Boucquillon









*Regista
Bonheur hanging lamp*

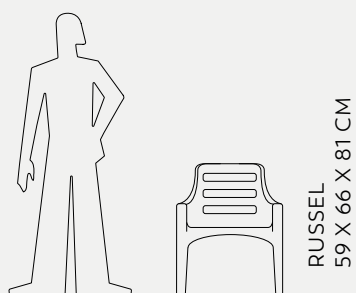

CHAIRS

RUSSEL

Vico Magistretti





*Russell chair
Lou Lou Table*



Russel chair
Oasis
Marcantonio Au Mur





CHAIRS

SOLEA

Design Giovanni Jacobone e Massimo Roj
Progetto CMR





Solea chair



Solea chair
Banqu  t   table



Solea chair
Lou Lou Table

Lampa-Daria hanging lamp
Ming High



TABLES, COFFEE TABLES & COUNTER BAR

TABLES >



BANQUÉTÉ
pag. 258



DUETTO
pag. 260



LOU LOU LARGE & SLIM
pag. 264



NOTRE DAME RECTANGULAR
pag. 268



SOLEAT
pag. 270

COFFEE TABLES >



DADO
pag. 276



HANDY 45
pag. 280



JUJU
pag. 282



LOU LOU
pag. 286



METEOR
pag. 290



MILO LOW
pag. 294



OLIVIA
pag. 318 (see Pool/Beach)



RUFFLE
pag. 396 (see Lights)



RIPPLE TABLE
pag. 58 (see Art)

COUNTER BAR >



CONE DRINK
pag. 68 (see Urban Furniture)



COUNTER BAR THE VASES
pag. 272

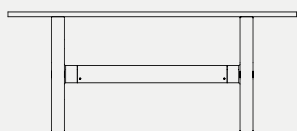

BANQUÉTÉ 200
200 X 100 X 75 CM

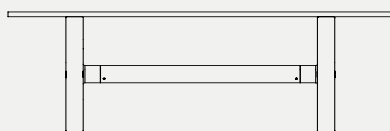

BANQUÉTÉ 240
240 X 100 X 75 CM

TABLES

BANQUÉTÉ

Calvi & Brambilla





*Banqu  t   table
Croisette armchairs*

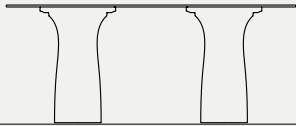
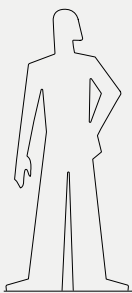

DUETTO
240/200 X 100 CM X 75 CM

TABLES

DUETTO

Serralunga



MOLESKIN FINISHING AVAILABLE





*Duetto table
Croisette Armchairs*





*Duetto table
Regista Chairs
Lindos Hanging Lamp*

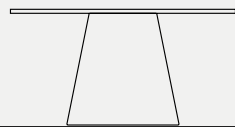

LOU LOU 70 LARGE
Ø140 X 72 CM

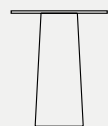

LOU LOU 70 SLIM
LOU LOU 70 SLIM WITH LIGHT ☼
Ø60 X 72 CM
60 X 60 X 72 CM
Ø70 X 72 CM
70 X 70 X 72 CM
Ø80 X 72 CM
80 X 80 X 72 CM
Ø60 X 72 CM
60 X 60 X 72 CM
Ø70 X 72 CM
70 X 70 X 72 CM
Ø80 X 72 CM
80 X 80 X 72 CM

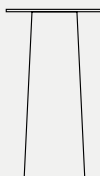

LOU LOU 105 SLIM
LOU LOU 105 SLIM WITH LIGHT ☼
Ø60 X 105 CM
60 X 60 X 105 CM
Ø70 X 105 CM
70 X 70 X 105 CM
Ø80 X 105 CM
80 X 80 X 105 CM
Ø60 X 105 CM
60 X 60 X 105 CM
Ø70 X 105 CM
70 X 70 X 105 CM
Ø80 X 105 CM
80 X 80 X 105 CM

TABLES

LOU LOU

Raffaella Mangiarotti





Lou Lou 70 Slim table
Regista chair

**AWARD WINNER
NYCxDESIGN 2019**

Lou Lou 70 Large top
in HPL Slate colour



*Lou Lou 70 large table — Regista T17 Chair — Bonheur Floor Lamp
Hour Sofa — Kabin vase — Kubrick armchair*



*Lou Lou Slim with Carrara Top
Croisette Armchair*



*Lou Lou Slim with Lavagna Top
Croisette Armchair*

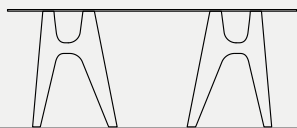
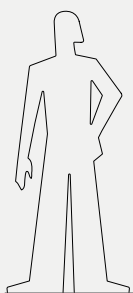

NOTREDAME RETTANGOLARE
180 X 90 CM X 72,5 CM

TABLES

NOTREDAME

Raffaella Mangiarotti





Notredame table

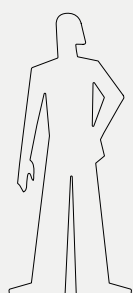

SOLEA TABLES
Ø 70 X 73 CM
70 X 70 X 73 CM

TABLES

SOLEA T

Progetto CMR

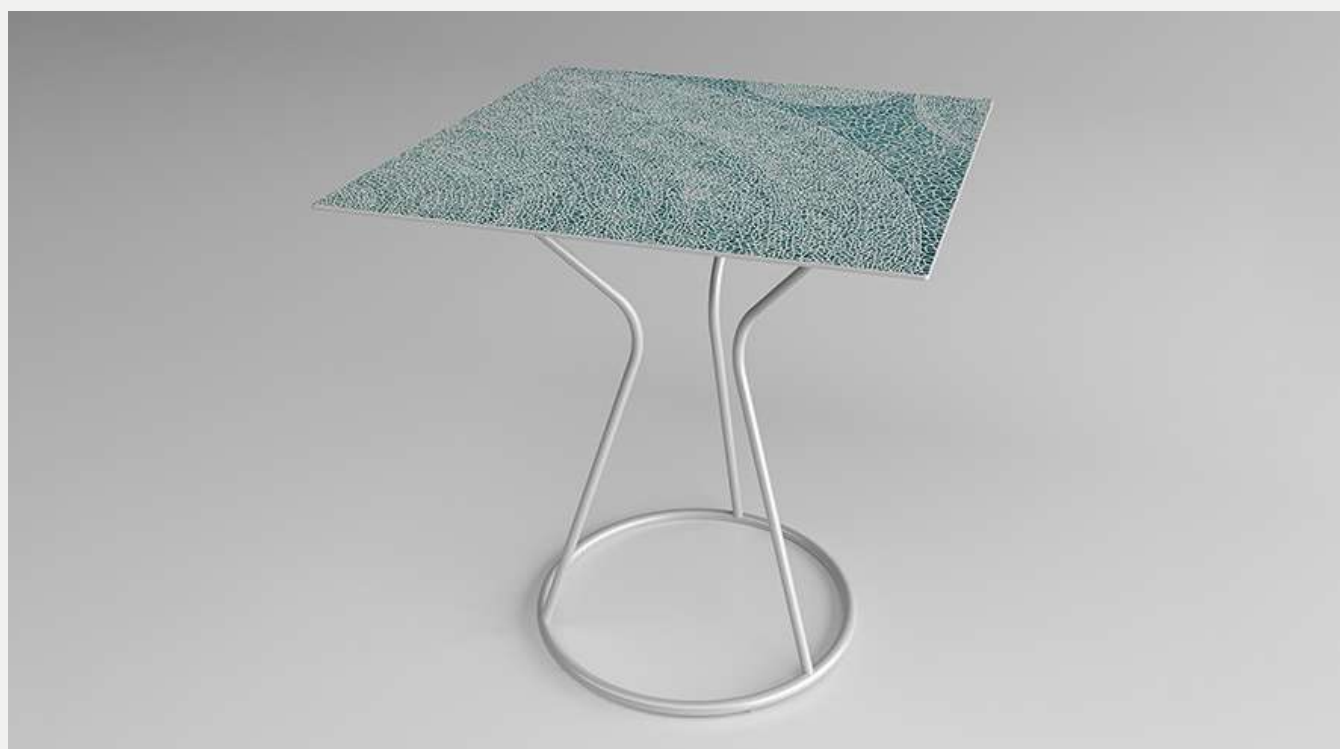



*Solea T Table
Croisette Chairs*

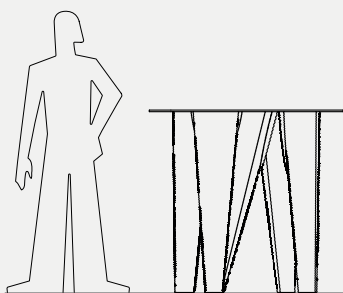

COUNTER BAR THE VASES
COUNTER BAR THE VASES WITH LIGHT ✨
120 X 96 X 113 CM

✨ AVAILABLE WITH LIGHT

TABLES

COUNTER BAR THE VASES

Ron Arad





Counter Bar The Vases



*Odette Floor Lamp
Counter Bar The Vases*

*Bay Lounge with light
Juju table*



Sirchester armchair and sofa with light

*HollyAll with light
Lou Lou table*

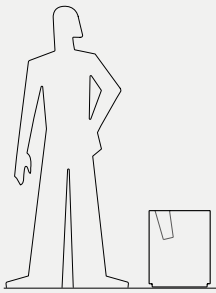

DADO
DADO WITH LIGHT ✨
38 X 38 X 47 CM

✨ AVAILABLE WITH LIGHT

COFFEE TABLES

DADO

Fabio Bortolani e Ermanno Righi





Dado
Kubrick armchair
Sirchester sofa





Dado
Lazy sunbed

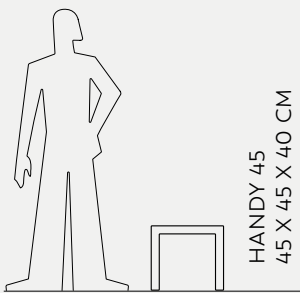

COFFEE TABLES

HANDY 45

Luisa Bocchietto





Handy 45
Giulietta

Lady Jane
Romeo



FURNITURE
CATEGORY

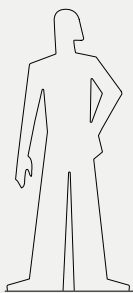

JUJU
JUJU WITH LIGHT ✨
Ø52 X 50 CM

COFFEE TABLES

JUJU

Garth Roberts

☼ AVAILABLE WITH LIGHT



MOLESKIN FINISHING AVAILABLE





Juju Moleskin Finishing



*Juju table
Pine Beach armchair*



Juju table
Pine Beach sofa



LOU LOU 34
 Ø60 X 35 CM
 60 X 60 X 35 CM



LOU LOU 40
 Ø60 X 41 CM
 60 X 60 X 41 CM
 Ø70 X 41 CM
 70 X 70 X 41 CM

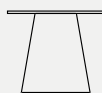

LOU LOU 50
 Ø60 X 51 CM
 60 X 60 X 51 CM
 Ø70 X 51 CM
 70 X 70 X 51 CM
 Ø80 X 51 CM
 80 X 80 X 51 CM

COFFEE TABLES

LOU LOU

Raffaella Mangiarotti





Lou Lou table — Matt metallic lacquered finishing



*Lou Lou Tables with Carrara Top
Ruffle Lamp
Time Out Armchair*



Lou Lou – Matt metallic lacquered finishing



METEOR-S
METEOR-S WITH LIGHT ☺
57 X 50 X 30 CM



METEOR-M
METEOR-M WITH LIGHT ☺
87 X 52 X 32 CM



METEOR-L
METEOR-L WITH LIGHT ☺
117 X 69 X 34 CM

COFFEE TABLES

METEOR

Arik Levy





Meteor table/bench with light



Meteor table/bench with light



*Meteor table/bench
Juju table*

*Bay armchair
Pine Beach sofa*

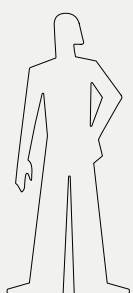

MILO LOW
MILO LOW WITH LIGHT ✕
59,5 X 59,5 X 56 CM

COFFEE TABLES

MILO LOW

Aquiliaalberg





Milo table
Cero stool



POOL, BEACH & SPA



AQUA
pag. 298



AQUA PLANO
pag. 310



KENTIA
pag. 308



LOUNGE CUBE
pag. 346 (see Stools)



LAZY LETTINO
pag. 310



LAZY SDRAIO
pag. 310



OASIS
pag. 314



OLIVIA
pag. 318



PALENQUERA
pag. 320



RAMO
pag. 322

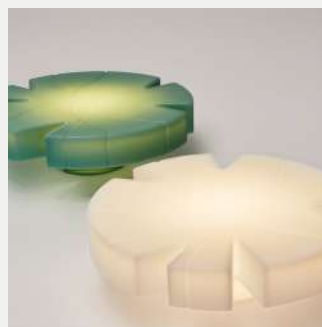

FIORE DI LOTO
pag. 304

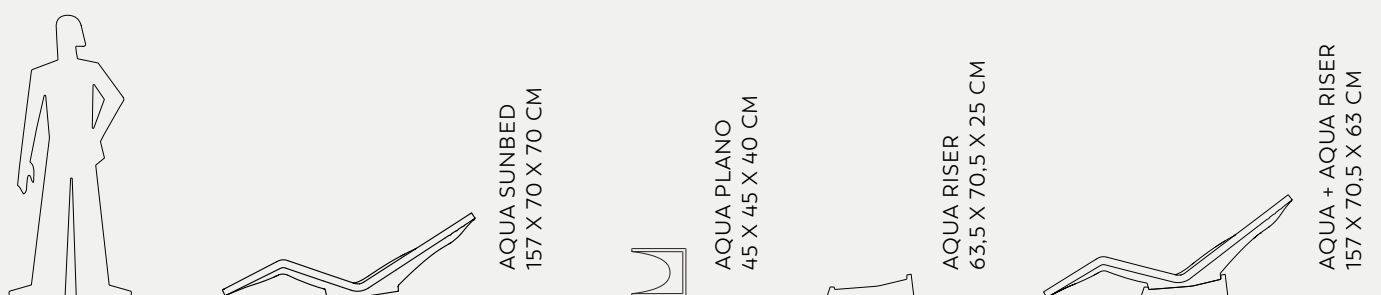

 MOLESKIN FINISHING AVAILABLE

POOL/BEACH/SPA

AQUA

MARC SADLER





*Aqua sunbed - Moleskin Finishing
Lounge Cube - Moleskin Finishing*



*Aqua sunbed
Dolcevita armchair*



Olivia table



*Aqua sunbed - Moleskin Finishing
Ruffle lamp*



*Aqua sunbed
Aqua sunbed with riser
Aquaplano table Moleskin finishing
Longue Cube Moleskin finishing*

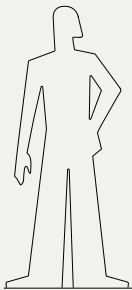

FIORE DI LOTO
Ø 45 X 14 CM

POOL/BEACH/SPA

FIORE DI LOTO

Marta Sansoni

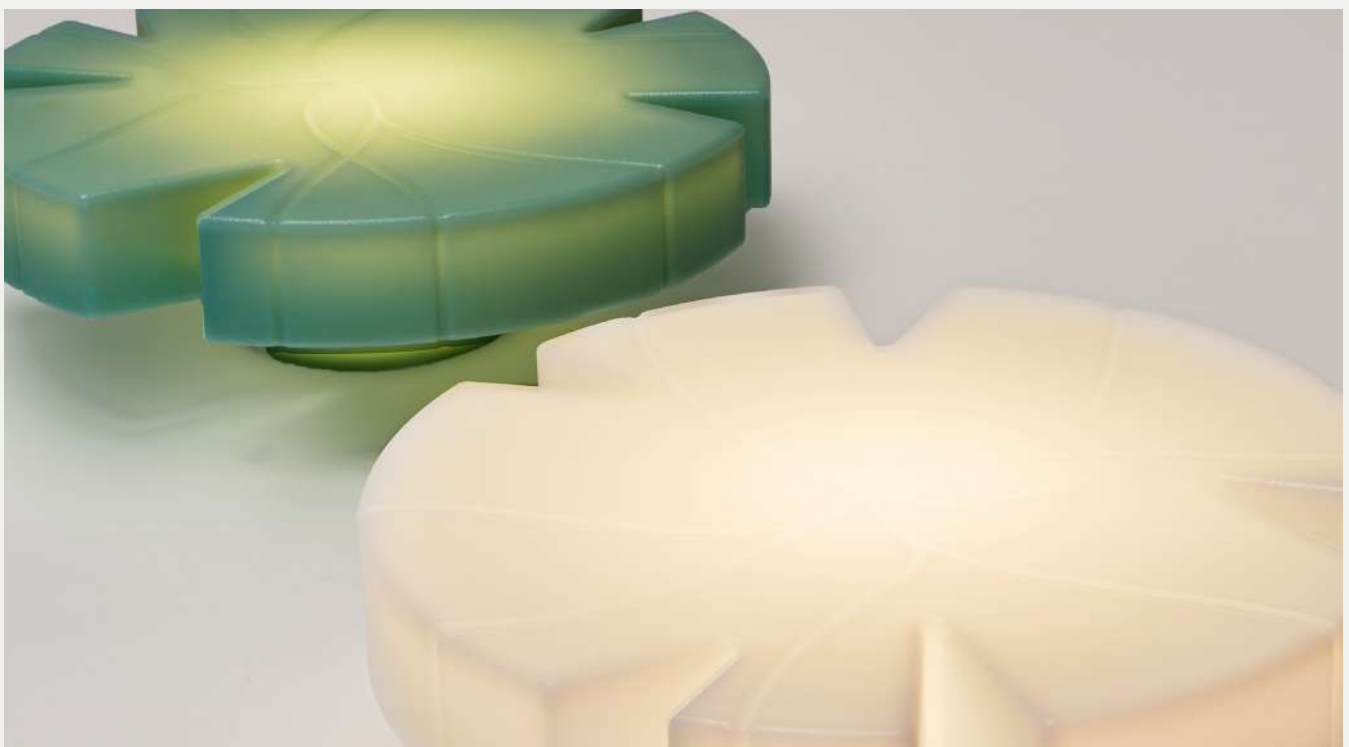

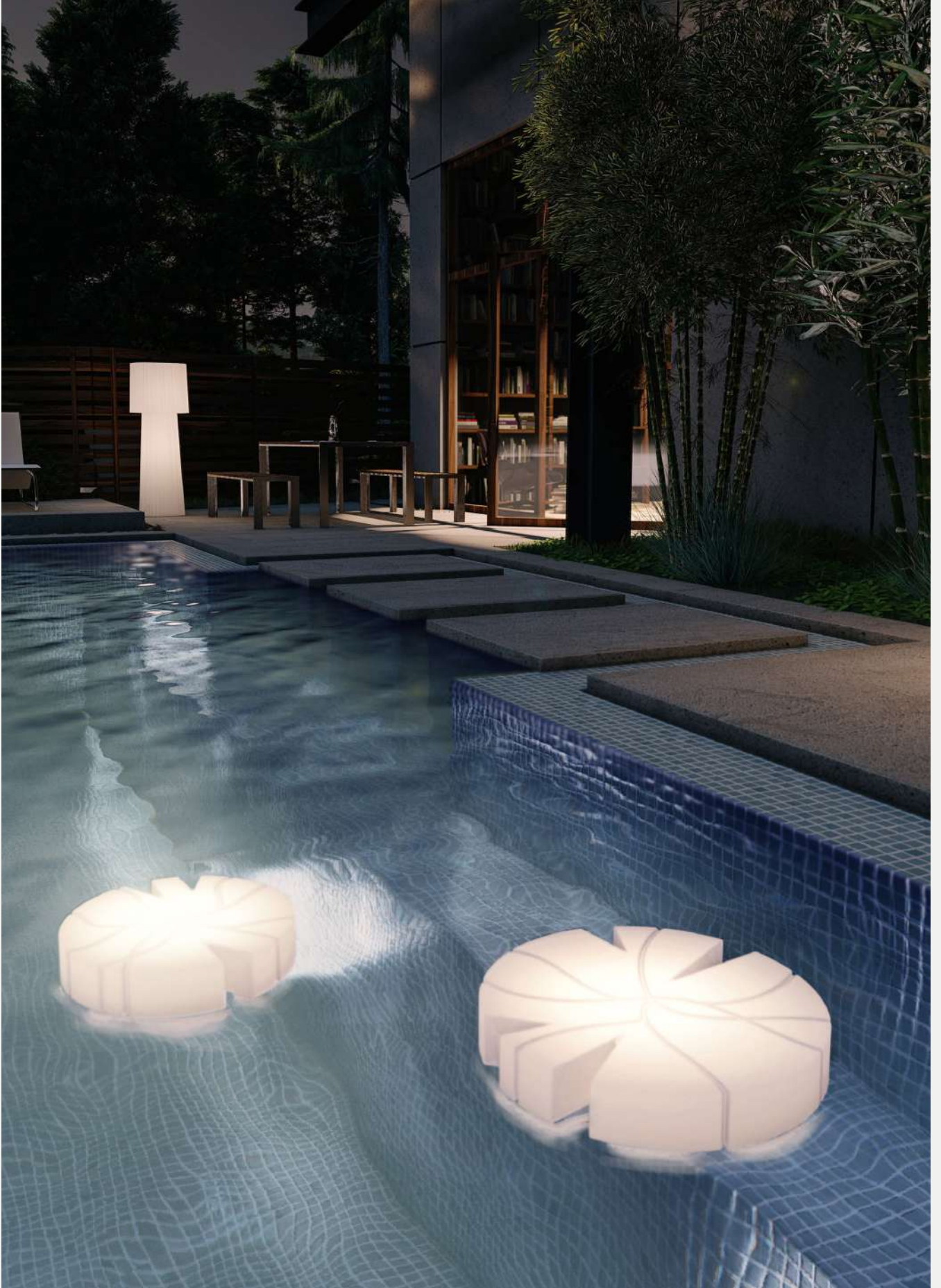

Fiore di Loto



Fiore di Loto



Fiore di Loto

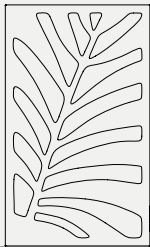
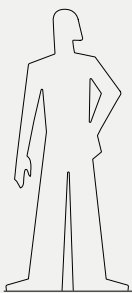

KENTIA
90 X 5 X 150 CM

POOL/BEACH/SPA

KENTIA

Lineeverdi



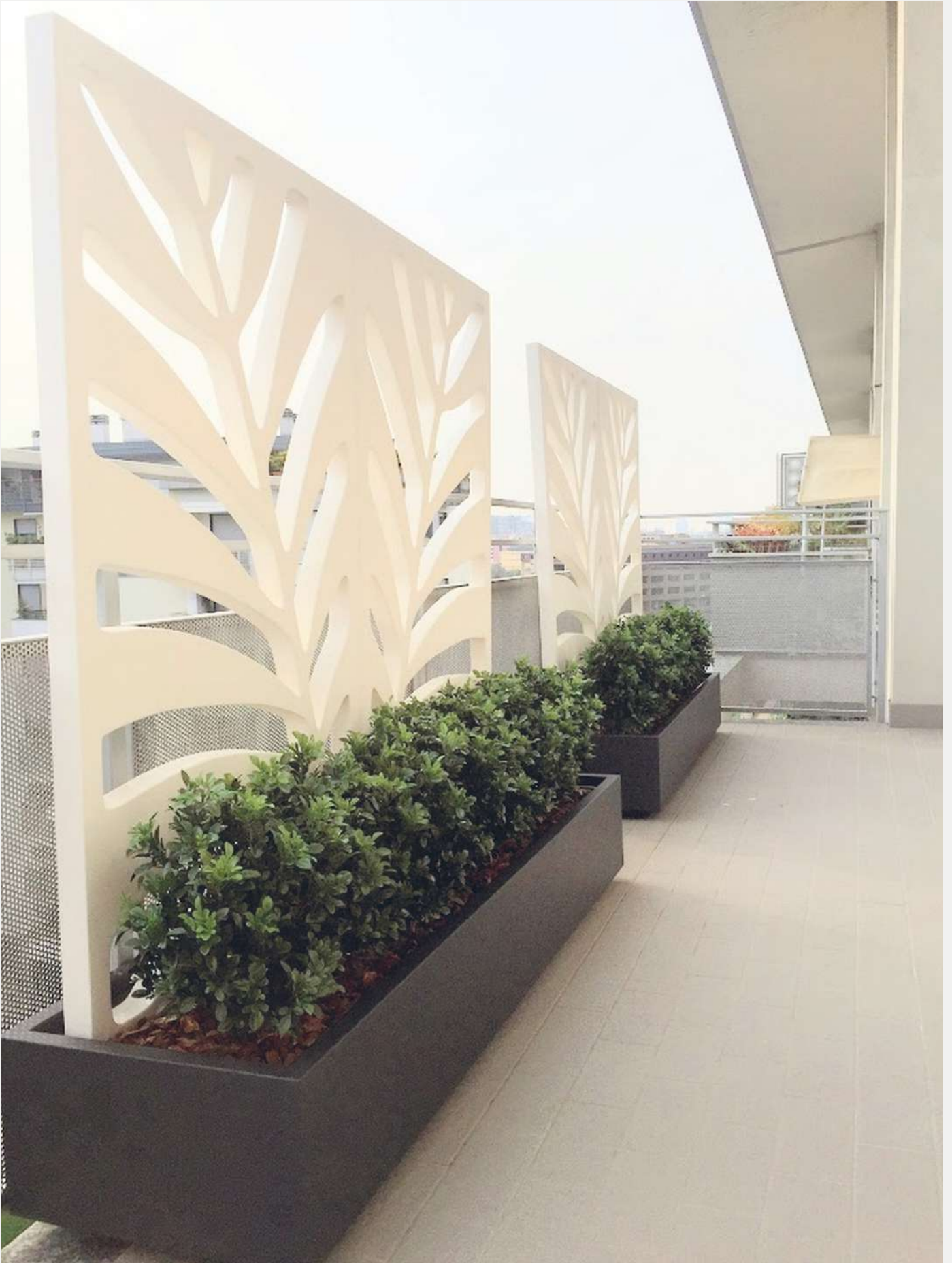

Kentia

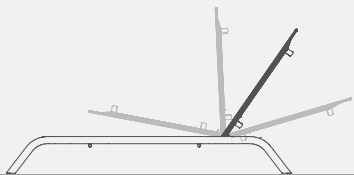
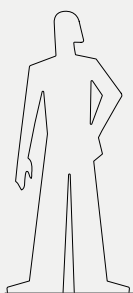

LAZY LETTINO / LAZY SUNBED
72 X 172 X 23 CM

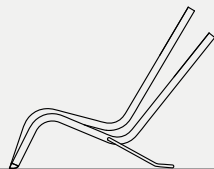

LAZY SDRAIO / LAZY DECKCHAIR
71 X 116/128 X 84/100 CM

POOL/BEACH/SPA

LAZY

Michel Boucquillon





Lazy sunbed



*Lazy sunbed
Lou Lou table*



Lazy deckchair

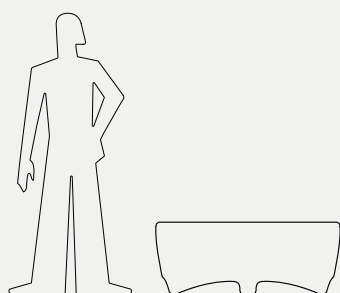

OASIS
115 X 115 X 45 CM

POOL/BEACH/SPA

OASIS

Sebastian Bergne





Oasis table version



*Oasis umbrella holder version
Aqua*



Oasis seat version with light

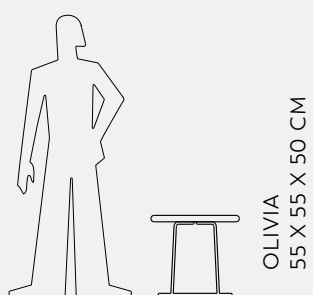

POOL/BEACH/SPA

OLIVIA

Serralunga





*Olivia table
Palanquera
Dolcevita armchair
Aqua sunbed*

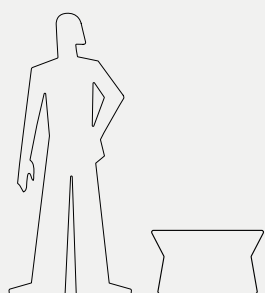

PALENQUERA
PALENQUERA WITH LIGHT ✂
70 X 30 X 40 CM

POOL/BEACH/SPA

PALENQUERA

Lina Obregon





Palenquera with light

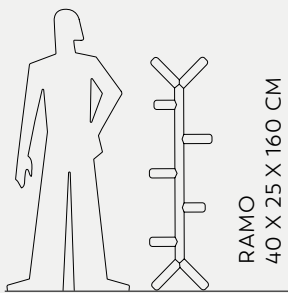

POOL/BEACH/SPA

RAMO

Emanuelle Jacques





Ramo



BENCHES



GIULIETTA
pag. 326



LOOP
pag. 330



LUBA
pag. 334



ROMEO
pag. 338

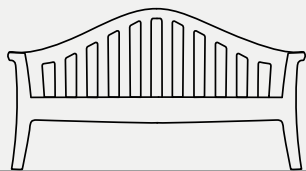
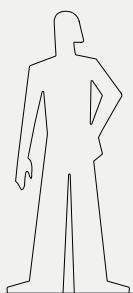

GIULIETTA
186 X 67 X 100 CM

BENCHES

GIULIETTA

Paolo Rizzatto





Giulietta



Giulietta

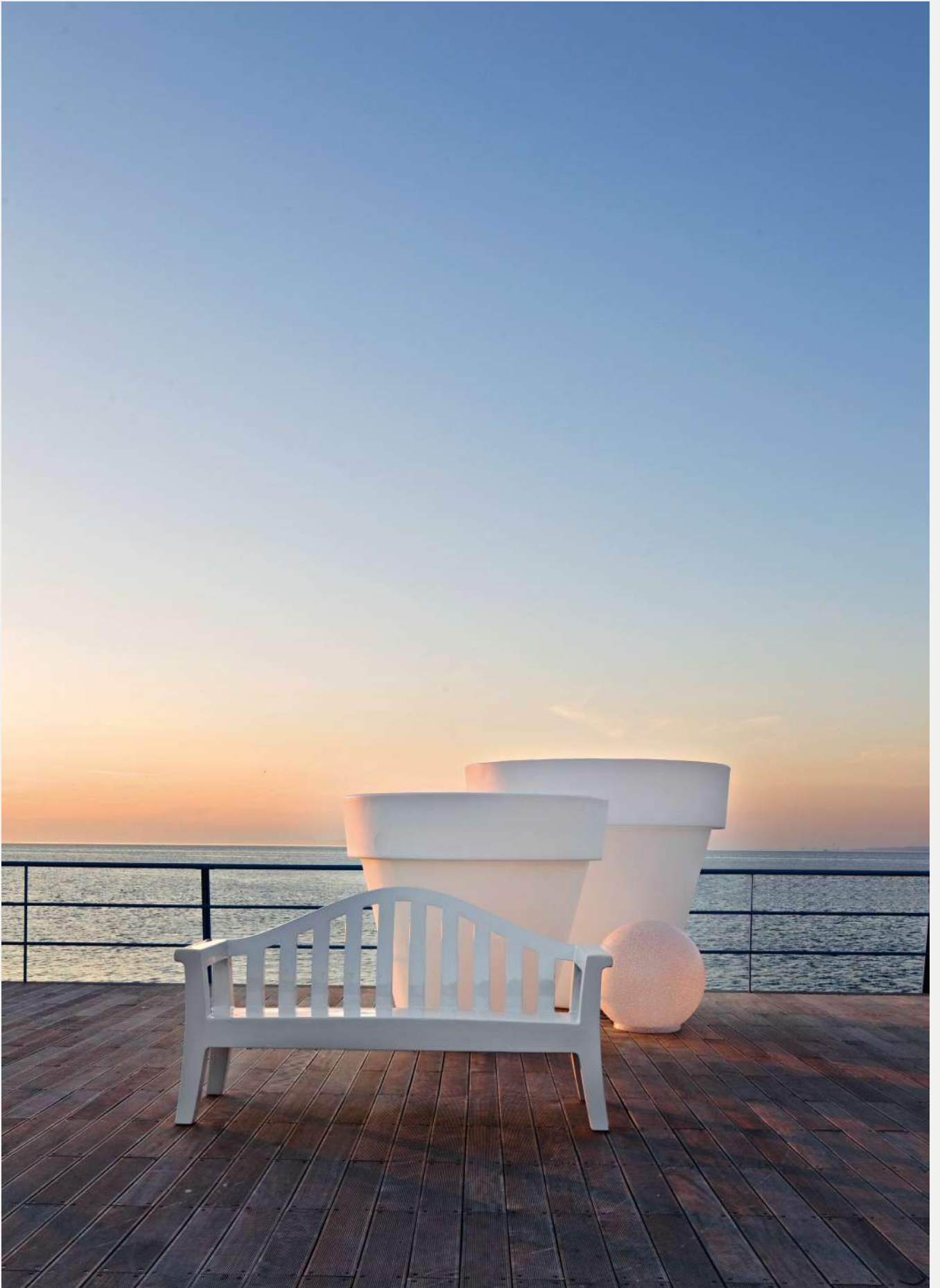

Giulietta
Crystal Moon

Vas-two
Big-Bo

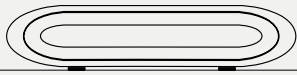

LOOP
LOOP WITH LIGHT ✕
180 X 50 X 40 CM



MOLESKIN FINISHING AVAILABLE

BENCHES

LOOP

Christophe Pillet





Loop - Moleskin Finishing



Sirchester sofa



Loop

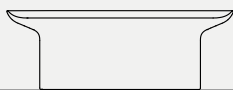
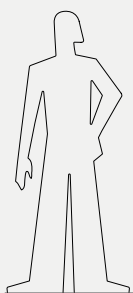

LUBA
LUBA WITH LIGHT ✂
141 X 45,5 X 49 CM



MOLESKIN FINISHING AVAILABLE

BENCHES

LUBA

Ionna Vautrin





Luba





*Luba bench
Lou Lou tables*

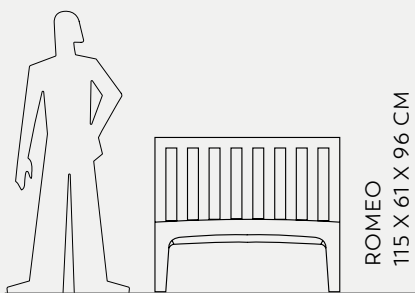

BENCHES

ROMEO

Paolo Rizzatto





Romeo bench — Lacquered finish



Romeo Bench



Romeo bench



STOOLS



CERO
pag. 344



LOUNGE CUBE
pag. 346



PORCINO
pag. 348

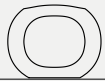
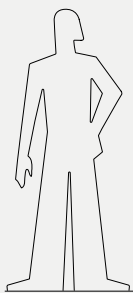

CERO
58 X 40 X 45 CM



MOLESKIN FINISHING AVAILABLE
(only on the external parts)

STOOLS

CERO

Brian Steendyk





Cero - Moleskin Finishing
Juju - Moleskin Finishing

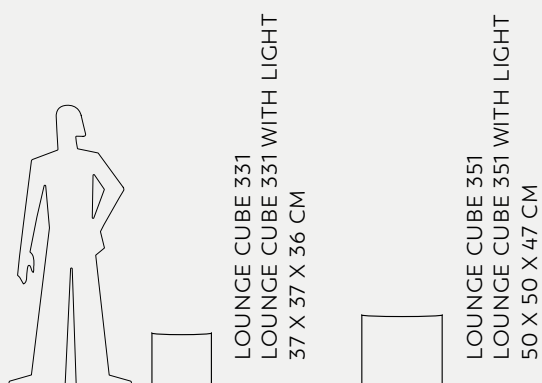

 MOLESKIN FINISHING AVAILABLE

STOOLS

LOUNGE CUBE

Serralunga





Lounge Cube - Moleskin finishing

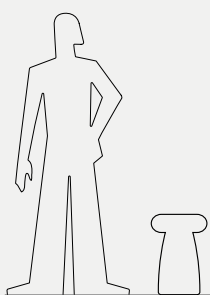

PORCINO
PORCINO WITH LIGHT ✕
PORCINO ASHTRAY ☉
35 X 35 X 50 CM



MOLESKIN FINISHING AVAILABLE



FINITURA PORCINO

STOOLS

PORCINO

Aldo Cibic





Porcino with light



Porcino



Porcino ashtray



LIGHTS



ATMOSFERA
pag. 356



AUNT JANE
pag. 360



BONHEUR
pag. 362



CRYSTAL MOON
pag. 366



CACTUS
pag. 416 (see Gift)



FLAME
pag. 368



FLORET
pag. 372

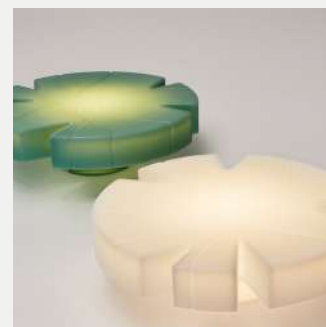

FIORE DI LOTO
pag. 304 (see Pool)



GRAND JANE
pag. 122 (see Pots)



GRAND MARY
pag. 122 (see Pots)



HONEY
pag. 374



LADY MARY / LADY JANE
pag. 376



LAMPA-DARIA
pag. 382



LINDOS
pag. 384



MISS JANE
pag. 388



ODETTE
pag. 390



PIC-NIC
pag. 394



RUFFLE
pag. 396



SCARLETT 140/180
pag. 400



TOP POT
pag. 404

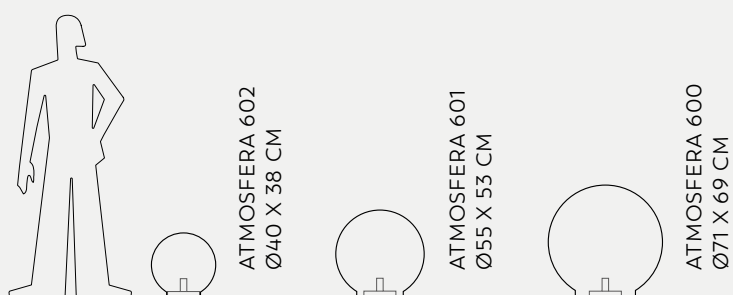

LIGHTS

ATMOSFERA

Serralunga







*Atmosfera
Giulietta*



Atmosfera

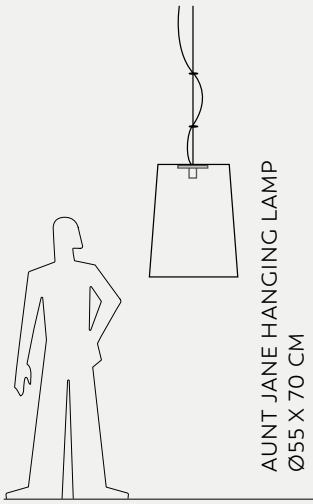

AUNT JANE HANGING LAMP
Ø55 X 70 CM

LIGHTS

AUNT JANE

Marc Sadler





Aunt Jane hanging lamp

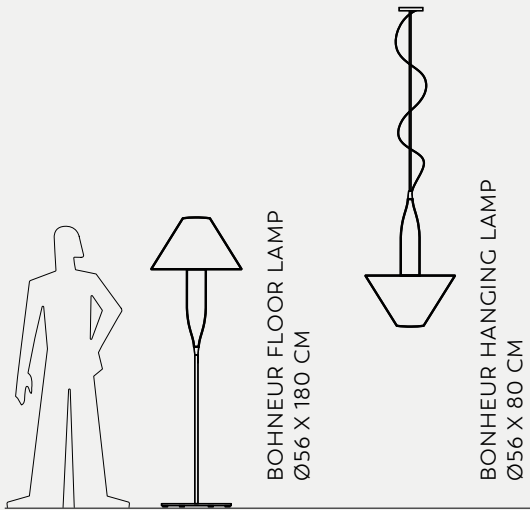

LIGHTS

BONHEUR

Michele De Lucchi / A. Nason





Bonheur floor lamp



Bonheur hanging lamp



Bonheur hanging lamp

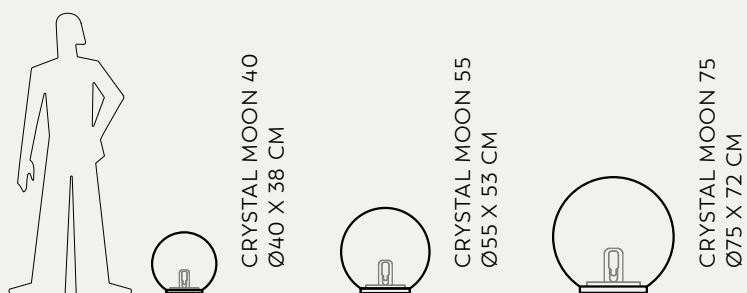

LIGHTS

CRYSTAL MOON

Serralunga





Crystal Moon finishing detail



FLAME
50 X 50 X 67,5 CM

LIGHTS

FLAME

Sebastian Bergne





Flame light



Flame light



Flame light

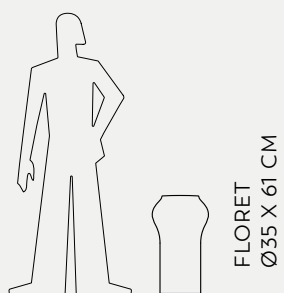

LIGHTS

FLORET

Raffaella Mangiarotti



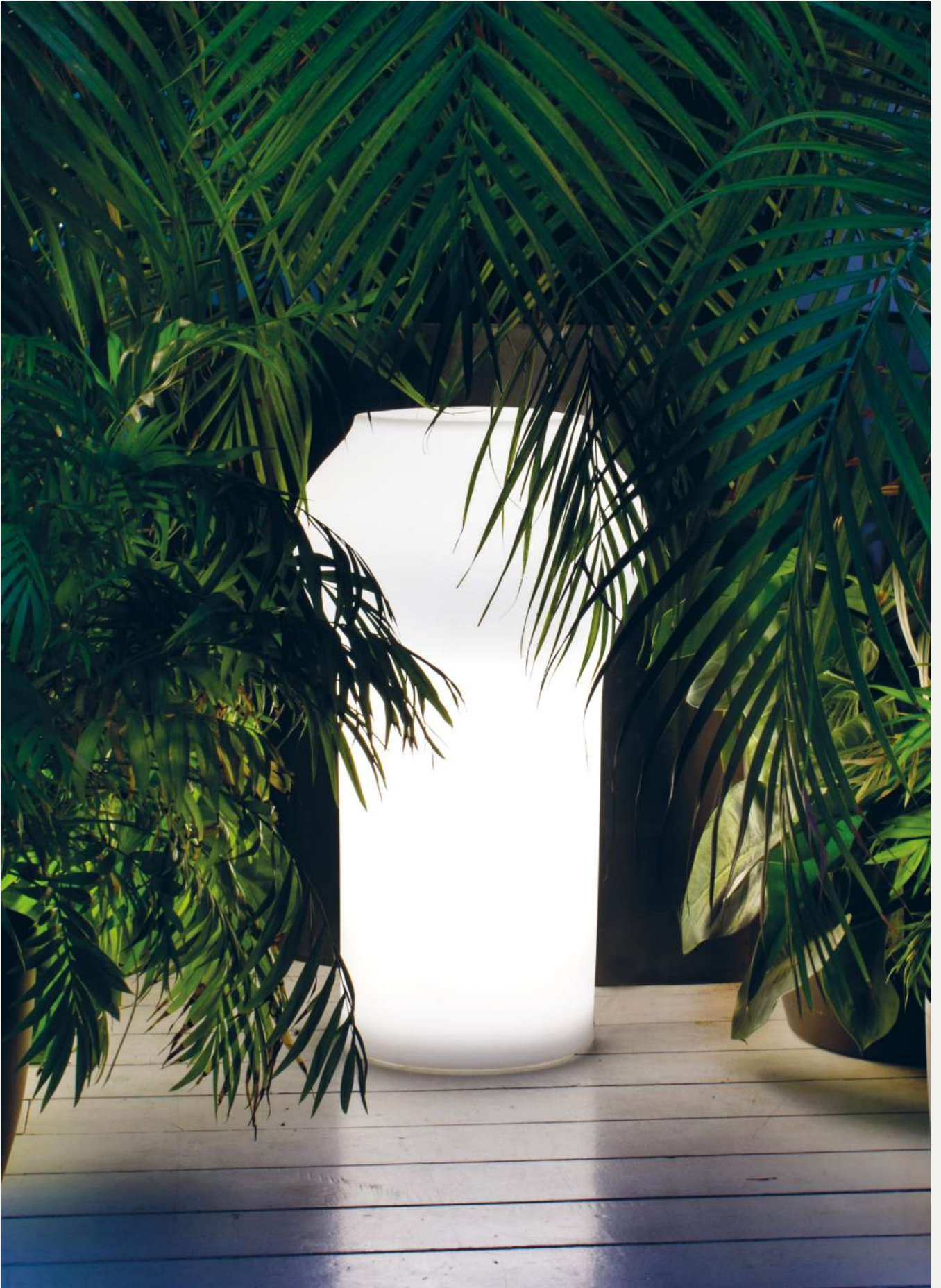

Floret

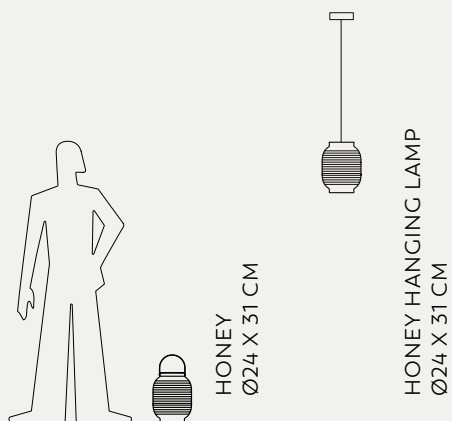

LIGHTS

HONEY

Raffaella Mangiarotti





Honey lantern

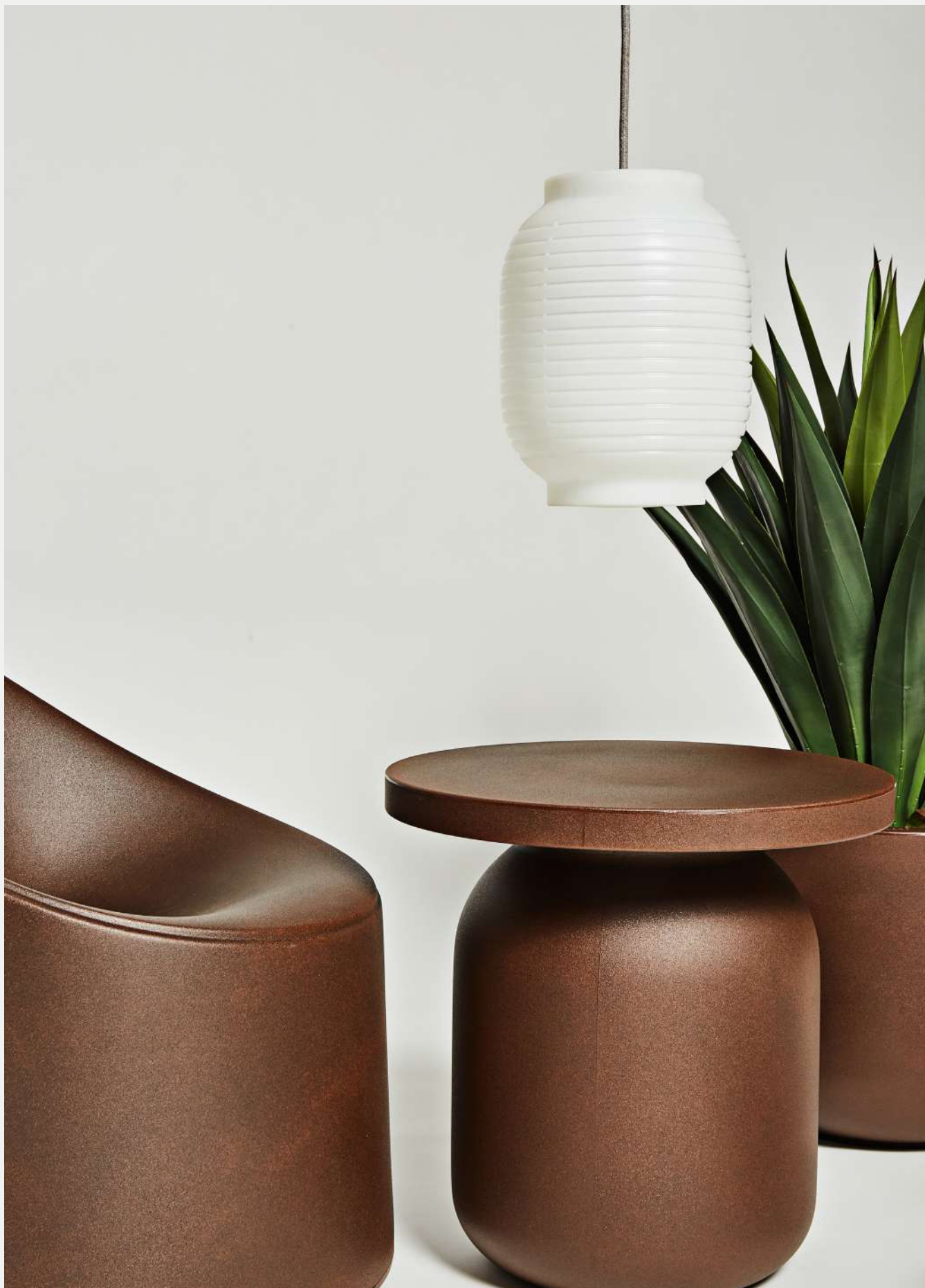

*Honey Hanging lamp
Bay corten Finishing
Juju corten Finishing
Cop corten Finishing*



Honey lantern

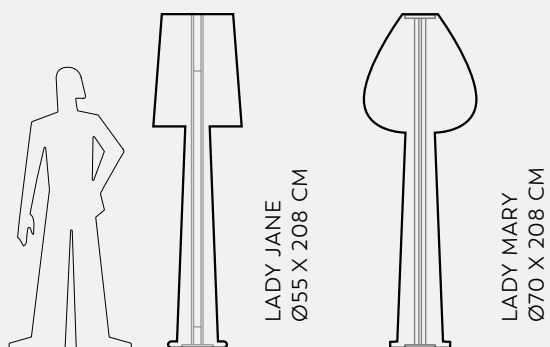

LIGHTS

LADY JANE / LADY MARY

Marc Sadler





Lady Jane



*Lady Jane
Canisse armchair and sofa*



Lady Jane

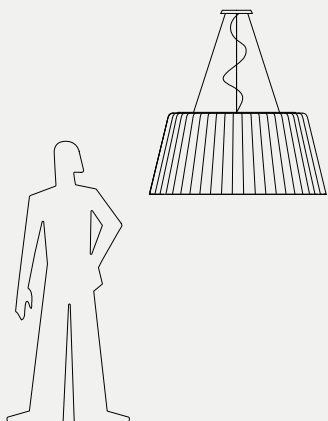

LAMPA-DARIA HANGING LAMP
Ø110 X 51 CM

LIGHTS

LAMPA-DARIA

Luisa Bocchietto





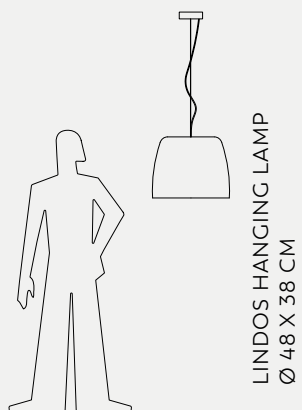

Lampa-Daria hanging lamp



LINDOS HANGING LAMP
Ø 48 X 38 CM

 ECO FRIENDLY FINISHING AVAILABLE
 MOLESKIN FINISHING AVAILABLE

LIGHTS

LINDOS

Serralunga





Lindos hanging lamp
Solea chair





Missed Tre 1 and Missed Tree 2

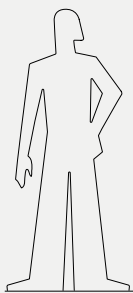

MISS JANE
Ø40 X 150 CM

LIGHTS

MISS JANE

Marc Sadler





Miss Jane — Matt metallic lacquered finishing

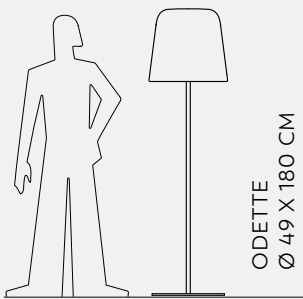

LIGHTS

ODETTE

Serralunga





*Odette Lamp
Juju Moleskin finishing
Pine beach sofa and armchair moleskin finishing*



Odette
Aqua
Oasis umbrella holder version



Odette
Aqua
Oasis umbrella holder version

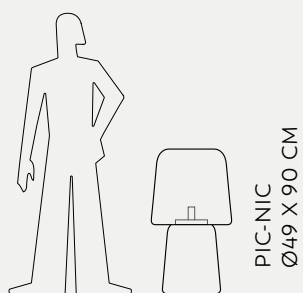

 MOLESKIN FINISHING AVAILABLE

LIGHTS

PIC-NIC

Joan Gaspar





Pic-Nic light - Moleskin finishing

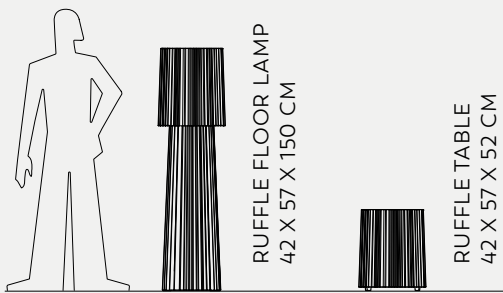

LIGHTS

RUFFLE

Garth Roberts





Ruffle lamp
Ruffle table



*Ruffle floor lamp
Croisette chair
Duetto table*



*Ruffle floor lamp
Croisette chair
Ming pots
Duetto table*

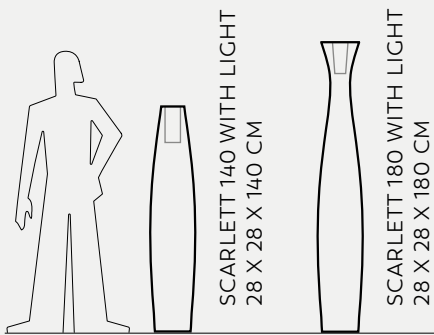

LIGHTS

SCARLETT

Christophe Pillet





Scarlett Lamp 180
Sirchester Sofa



Scarlett 180 with light



*Scarlett lamp 180
Sirchester armchair
Bonheur lamp*

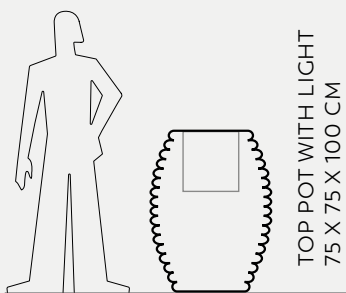

LIGHTS

TOP POT

Ron Arad





Top Pot

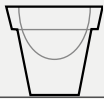
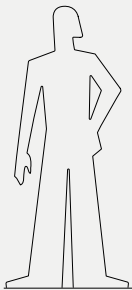

VAS-THREE
VAS-THREE WITH LIGHT ✨
60 X 60 X 55 CM

✨ AVAILABLE WITH LIGHT

LIGHTS

VAS-THREE

Luisa Bocchietto





Vas-Three with light

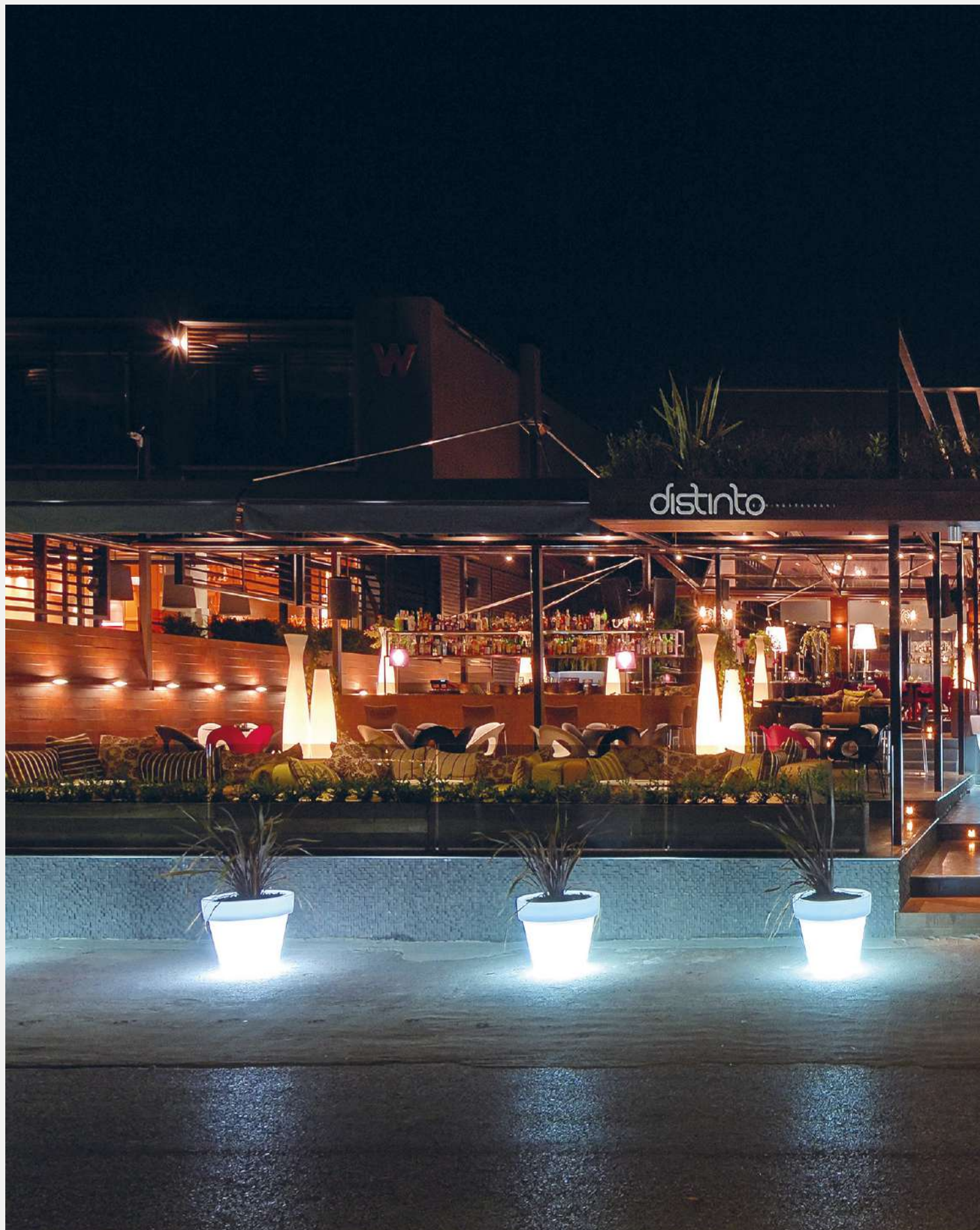

Scarlett 140 and 180 with light



Vas-Three and Vas-One with light



GIFTS



BINGO
pag. 412



BONNIE
pag. 414



CACTUS
pag. 416



DOGGY
pag. 420



GIANO
pag. 424



NEW-WAVE-S
pag. 426



OTTO
pag. 428



PALOMA E PULCINO
pag. 432



PLOMB
pag. 436



SKAL
pag. 438

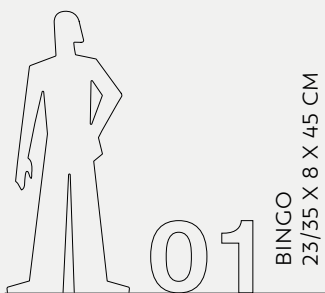

GIFTS

BINGO

Marta Daza Fernandez



18



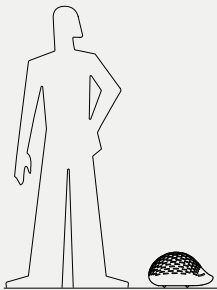

BONNIE
BONNIE WITH LIGHT ✨
40 X 22 X 27 CM

✨ AVAILABLE WITH LIGHT

GIFTS

BONNIE

Alessandra Baldereschi





Bonnie with light

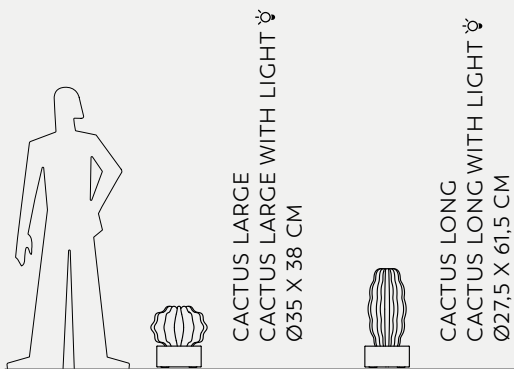

CACTUS LARGE
CACTUS LARGE WITH LIGHT ☽
Ø35 X 38 CM

CACTUS LONG
CACTUS LONG WITH LIGHT ☽
Ø27,5 X 61,5 CM

☽ AVAILABLE WITH LIGHT

GIFTS

CACTUS

Alessandra Baldereschi



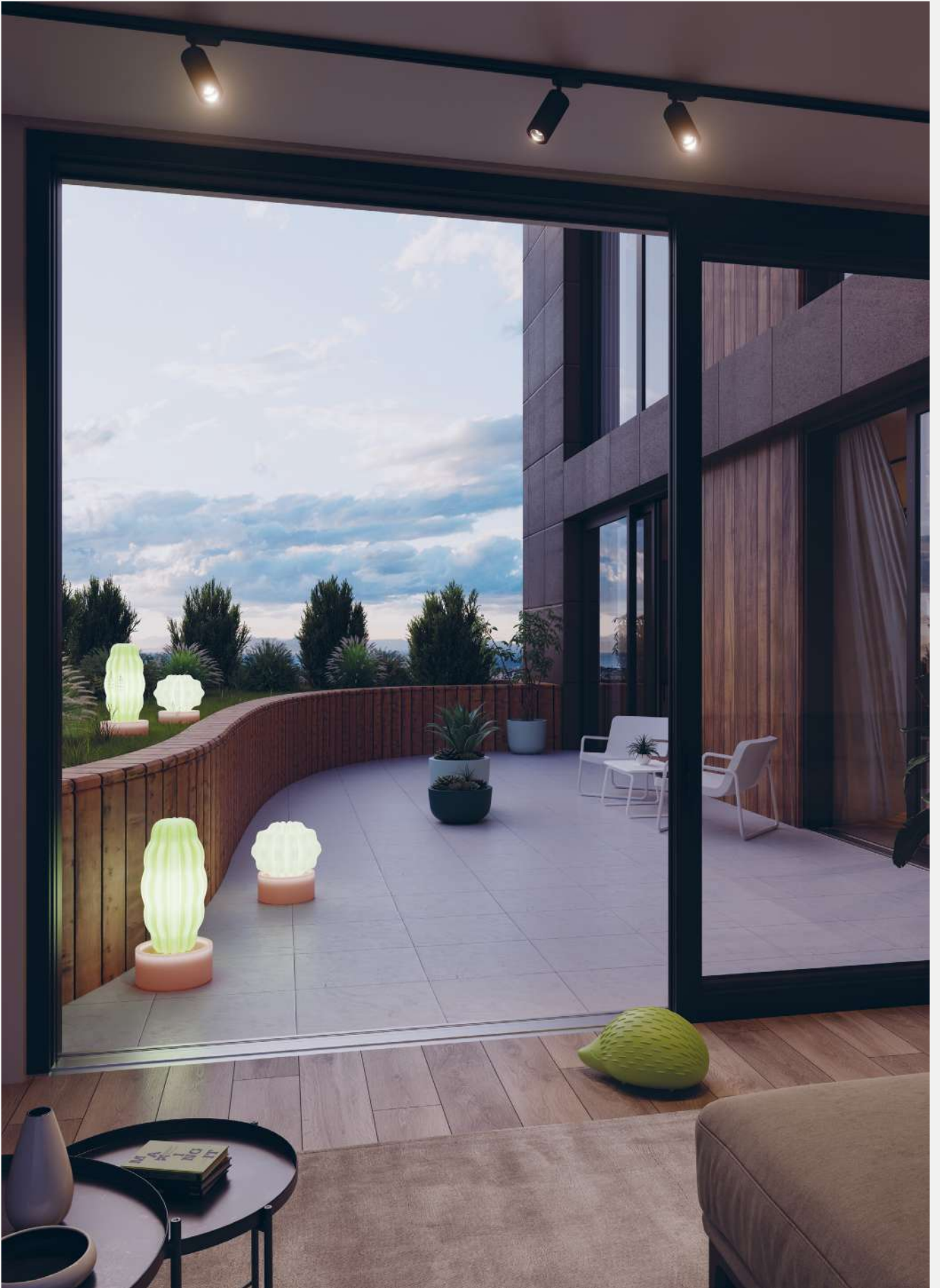

Cactus with light
Bonnie

Cup
Time out armchair
Dolcevita table



Cactus



Cactus with light

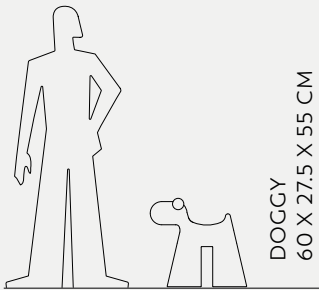

DOGGY
60 X 27,5 X 55 CM

GIFTS

DOGGY

Eero Aarnio



MOLESKIN FINISHING AVAILABLE



ECO FRIENDLY FINISHING AVAILABLE





Dalmatian Doggy



Doggy



Doggy

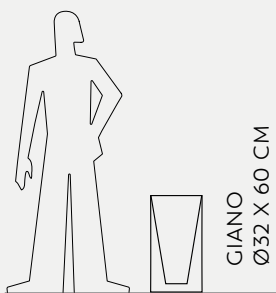

GIFTS

GIANO

Luisa Bocchietto





Giano

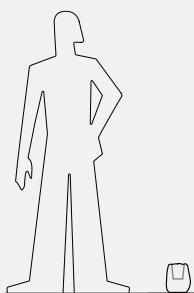

NEW-WAVE-S
Ø 15 X 18 CM

GIFTS

NEW-WAVE-S

Serralunga





New wave-s

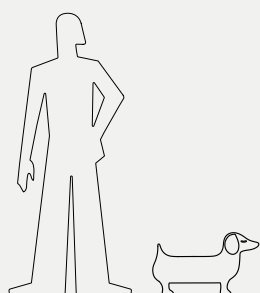

OTTO
OTTO WITH LIGHT ✨
66 X 17,5 X 38 CM



MOLESKIN FINISHING AVAILABLE

✨ AVAILABLE WITH LIGHT

GIFTS

OTTO

Alessandra Baldereschi





Otto and Otto with light
Bonnie



Doggy Moleskin Finishing
Otto Moleskin Finishing



Otto

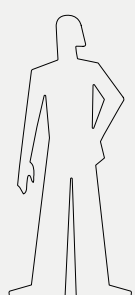

PALOMA
PALOMA WITH LIGHT ✨
130 X 37.5 X 52.5 CM



PULCINO
PULCINO WITH LIGHT ✨
80 X 27 X 39 CM

GIFTS

PALOMA E PULCINO

Eero Aarnio



MOLESKIN FINISHING AVAILABLE



AVAILABLE WITH LIGHT



ECO FRIENDLY FINISHING AVAILABLE





Paloma



Pulcino



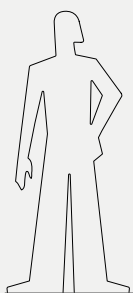

PLOMB
45 X 45 X 60 CM

GIFTS

PLOMB

Karim Rashid



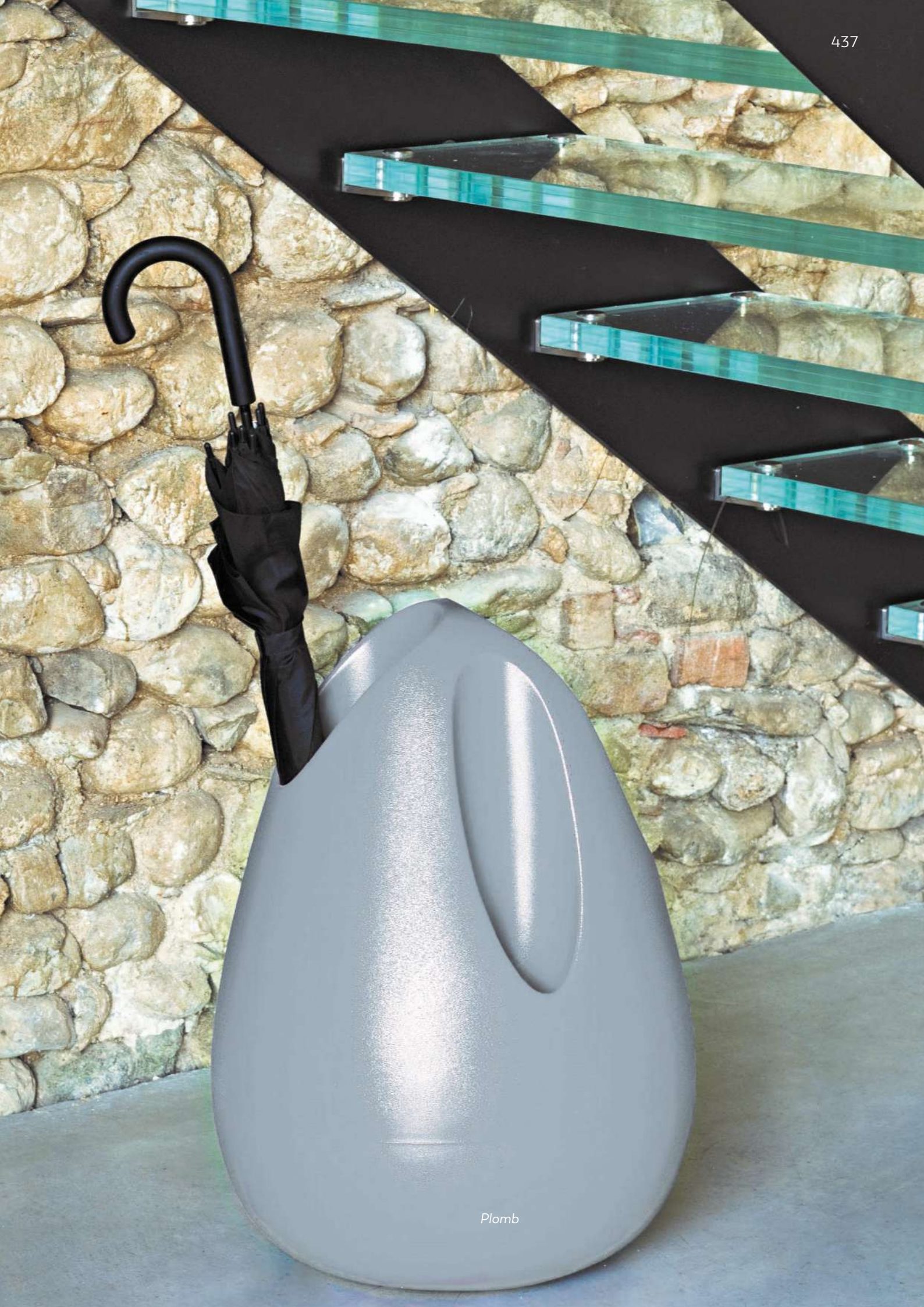

Plomb

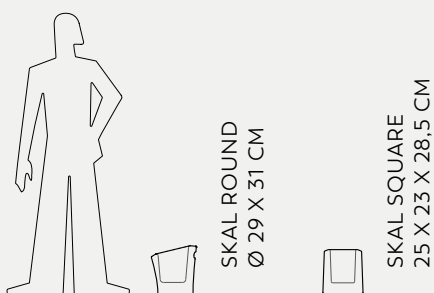

SKAL ROUND
Ø 29 X 31 CM

SKAL SQUARE
25 X 23 X 28.5 CM

GIFTS

SKAL

Serralunga





Skall



POTS ITALIAN TRADITION



**DECORATI ANFORA
RIGATA**
pag. 444



**DECORATI CALICE
DECORATO**
pag. 444



**DECORATI CALICE
FOGLIATO**
pag. 444



**DECORATI CASSETTA
FOGLIATA**
pag. 444



**DECORATI CIOTOLA
GIULIA**
pag. 444



**DECORATI COLONNA
FOGLIE**
pag. 444



DECORATI FESTONATO
pag. 444



**DECORATI FESTONATO
MAIOR**
pag. 444



DECORATI LIMONI
pag. 444



DECORATI ORCIO
pag. 444



**DECORATI ORCIO
FESTONATO**
pag. 444



**DECORATI QUADRO
FIORE**
pag. 444



**DECORATI RETTANGOLO
FESTONATO**
pag. 444



DECORATI UVA SPINA
pag. 444



DOPPIO BORDO
pag. 466



**GRANIGLIA CIOTOLA
RUVIDA**
pag. 454



**GRANIGLIA
RETTANGOLARE RUVIDA**
pag. 454



MILLERIGHE ALTO
pag. 456



MILLERIGHE ANGOLO
pag. 456



**MILLERIGHE ANGOLO
ORIZZONTALE**
pag. 456



MILLERIGHE PARETE
pag. 456



MILLERIGHE QUADRATO
pag. 456



**MILLERIGHE
RETTANGOLARE**
pag. 456



DINGHY SAUCERS
pag. 460



**RECTANGULAR AND
SQUARE SAUCERS**
pag. 462



ROUND SAUCERS
pag. 462



Delave finishing

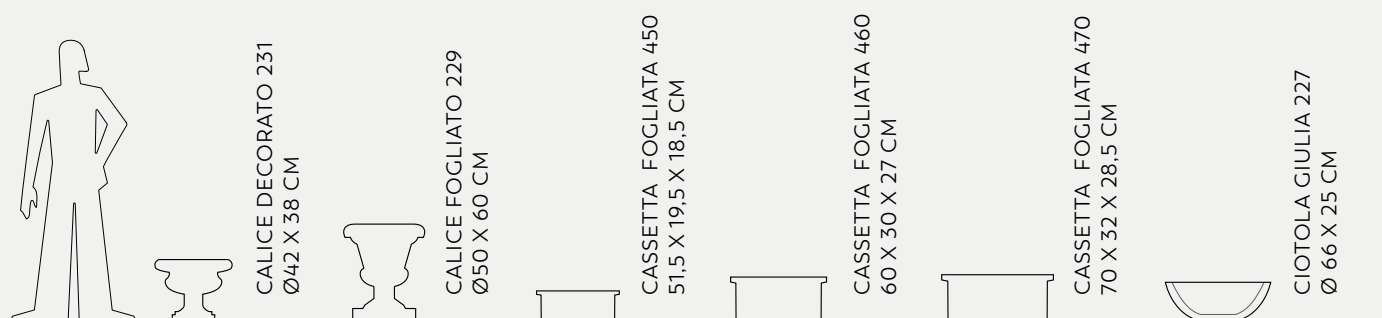

POTS - ITALIAN TRADITION

DECORATI

Serralunga



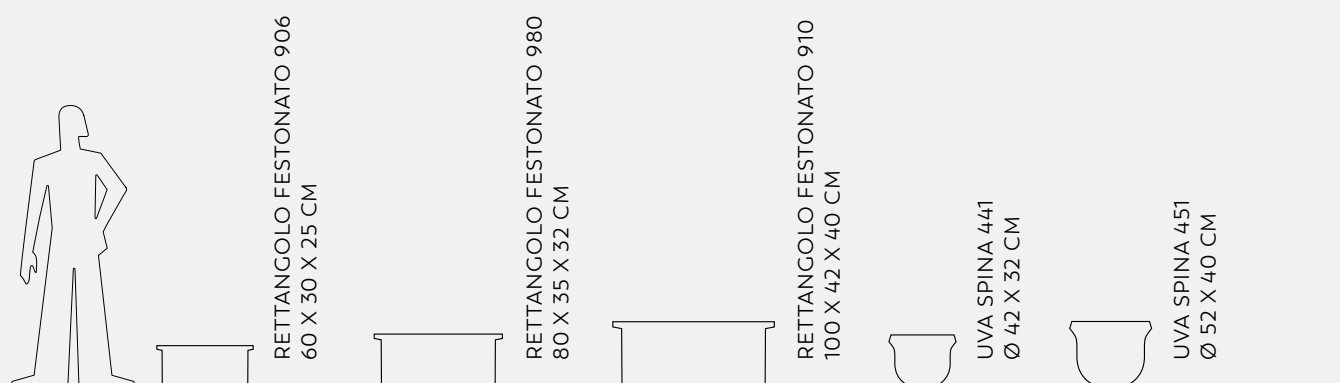
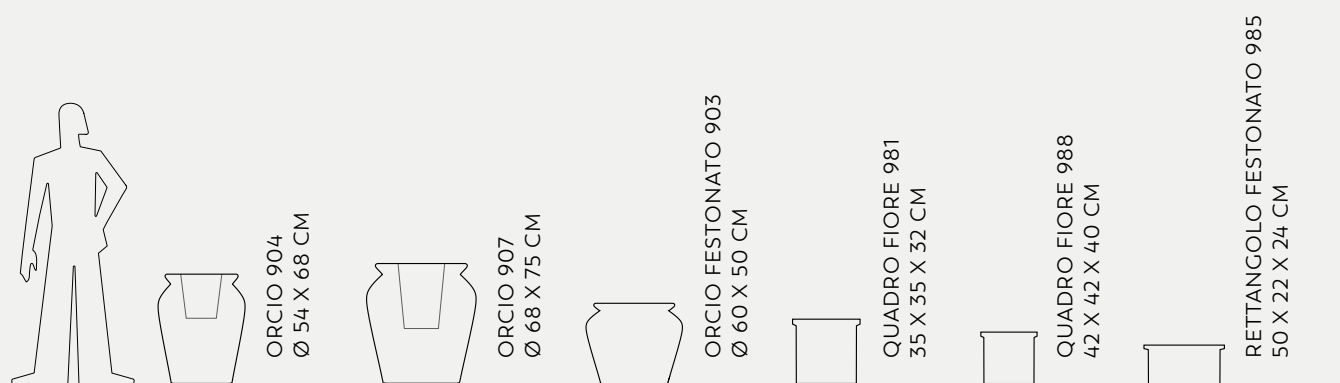
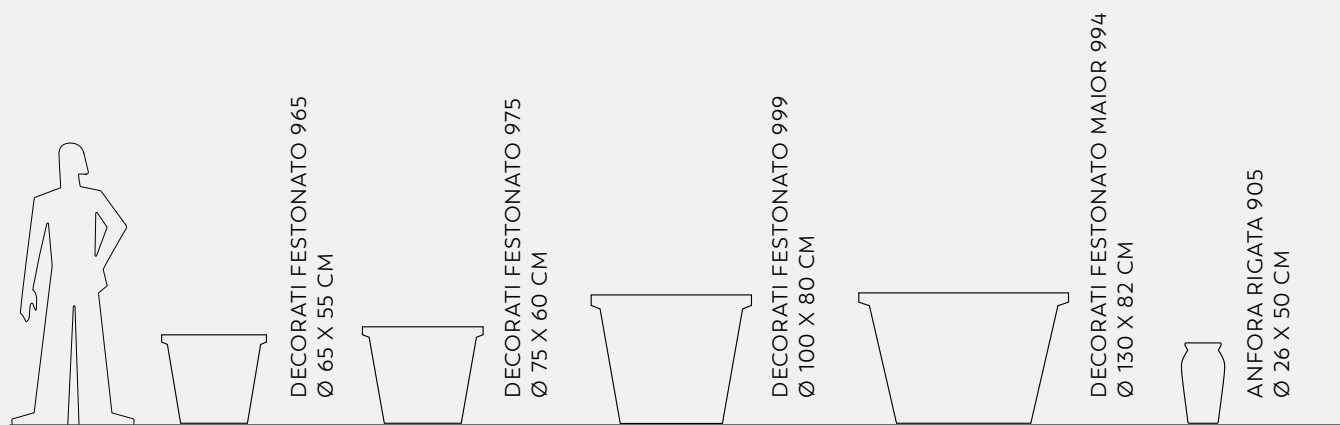



Decorati
Anfora rigata



Orcio festonato



Decorato festonato



Decorato festonato maior



Decorato festonato



Decorato uva spina

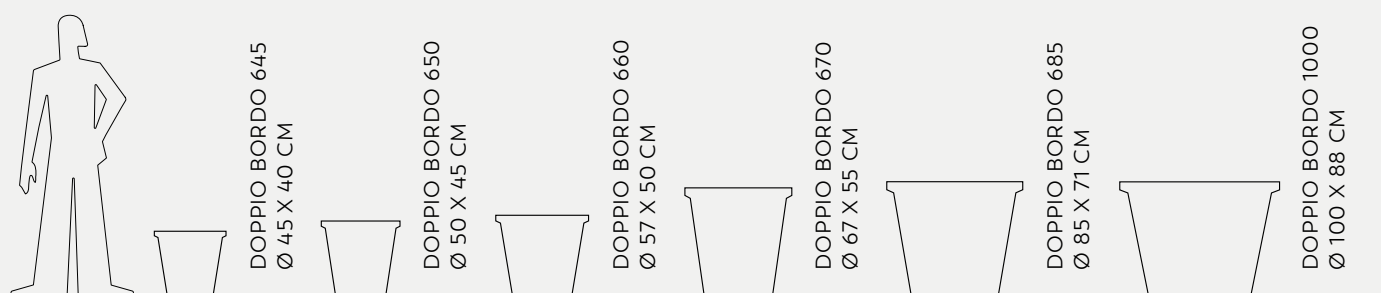

POTS - ITALIAN TRADITION

DOPPIO BORDO

Serralunga





Doppio bordo



CIOTOLA RUVIDA 251
Ø 42 X 20 CM



CIOTOLA RUVIDA 252
Ø 51 X 24 CM

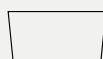

RETTANGOLARE RUVIDA 260
60 X 25 X 30 CM

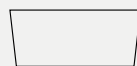

RETTANGOLARE RUVIDA 280
80 X 31 X 35 CM



GRANIGLIA SURFACE

POTS - ITALIAN TRADITION

GRANIGLIA

Serralunga

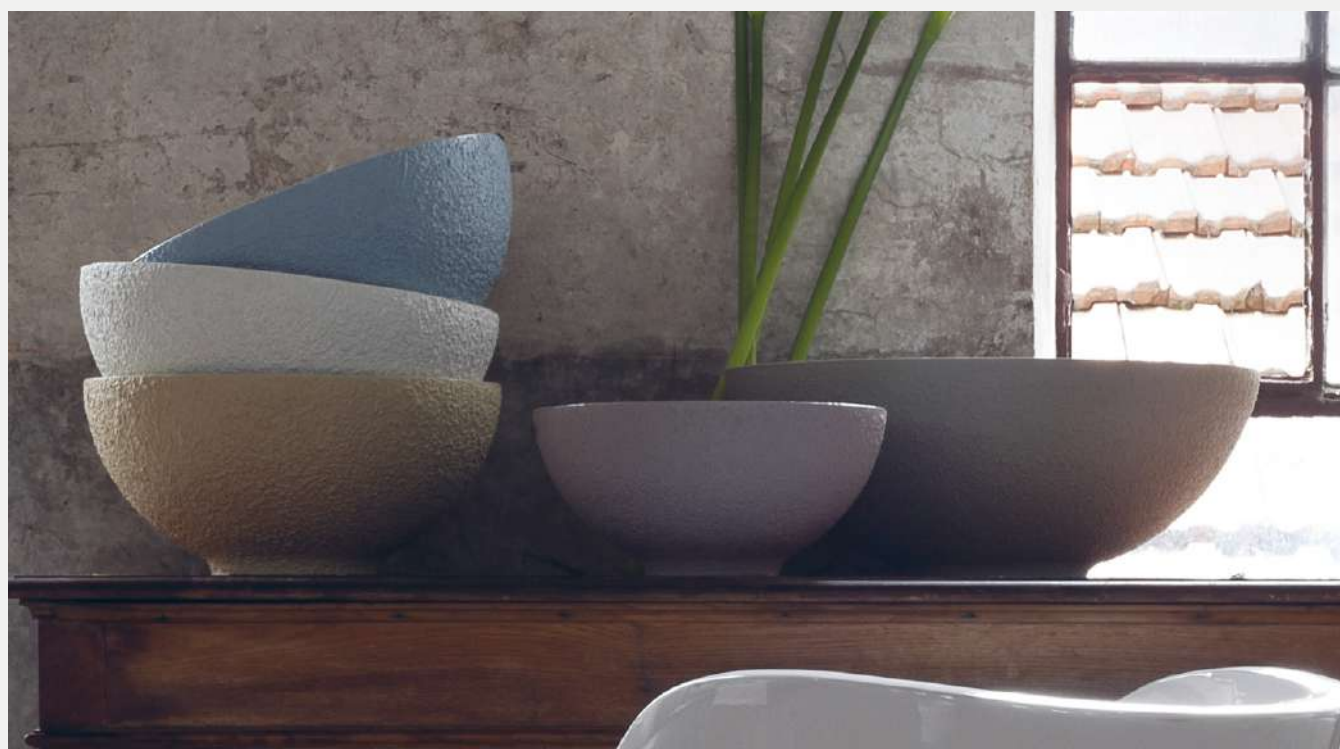



Graniglia rettangolare

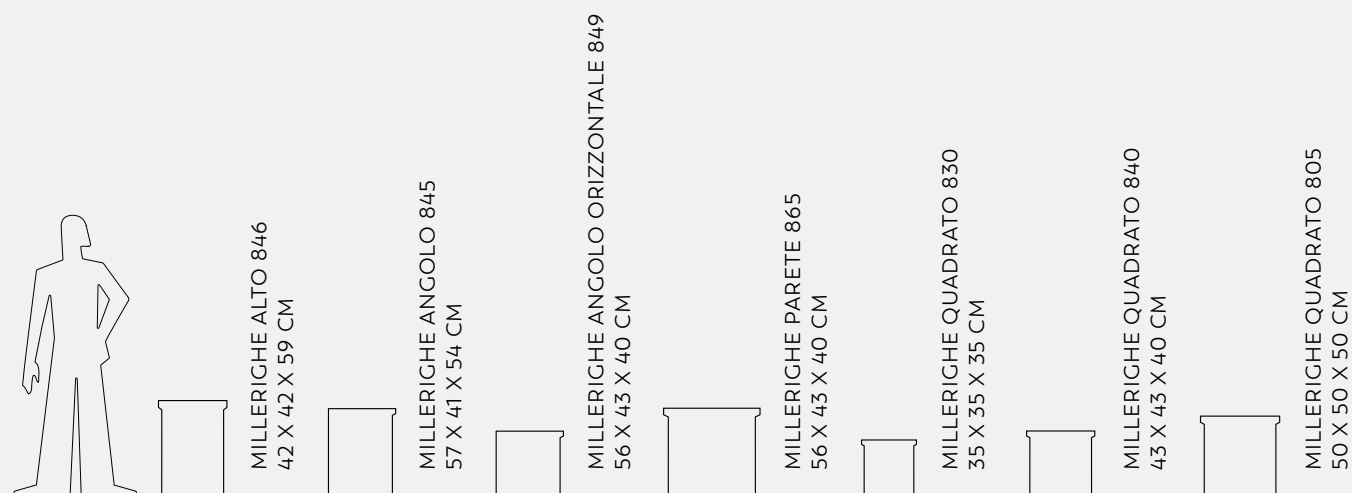
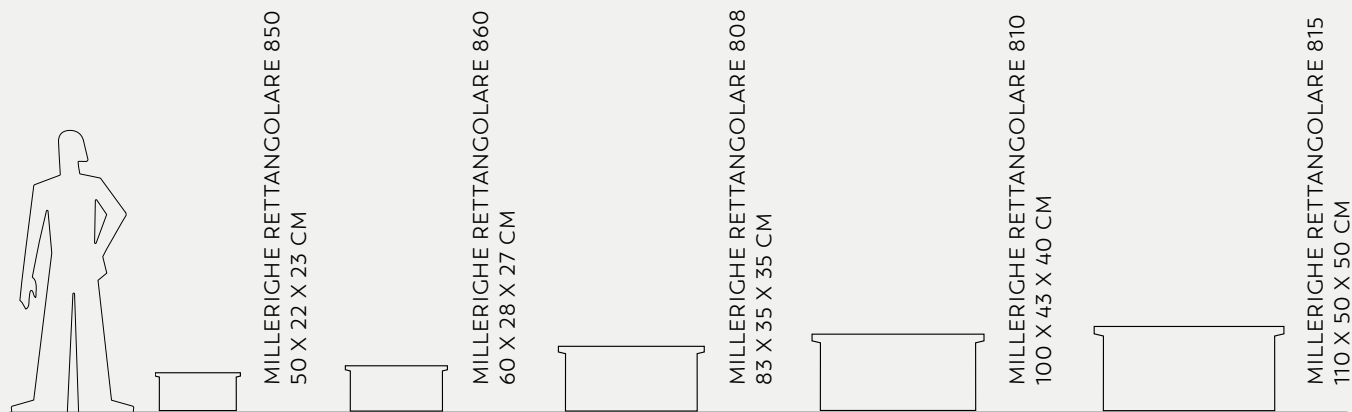

POTS - ITALIAN TRADITION

MILLERIGHE

Serralunga





Millerighe



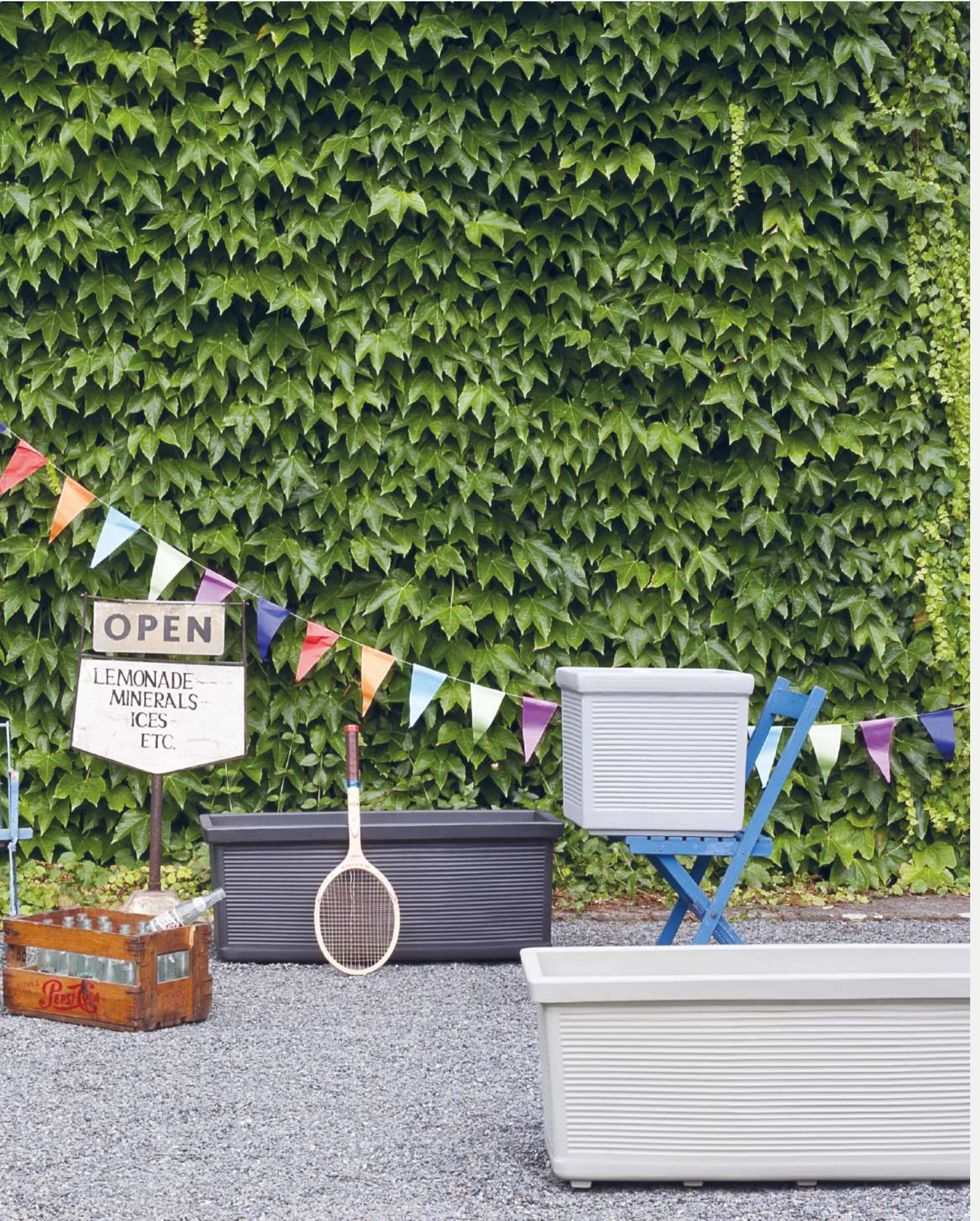

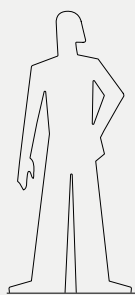

DINGHY27
Ø 23 X 6 CM



DINGHY32
Ø 28 X 6 CM



DINGHY39
Ø 35 X 6 CM



DINGHY49
Ø 49 X 6 CM



DINGHY69
Ø 69 X 6 CM



DINGHY85
Ø 85 X 6 CM

POTS - ITALIAN TRADITION

DINGHY SAUCERS

Serralunga





Dinghy saucers

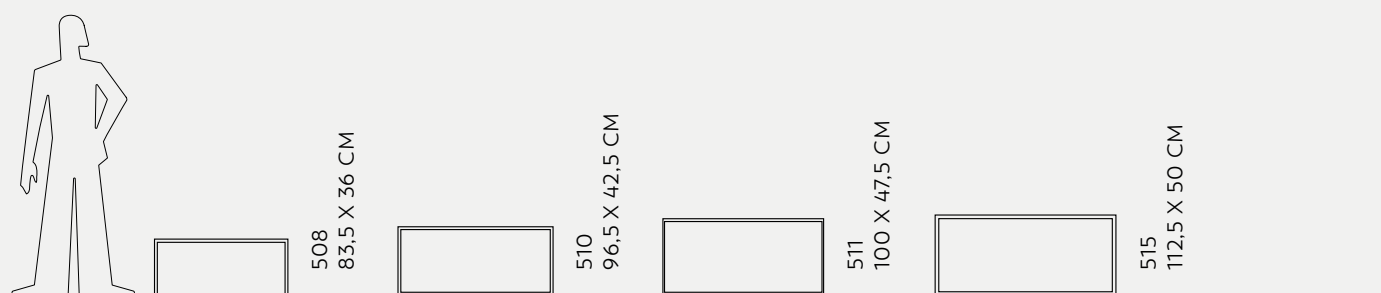
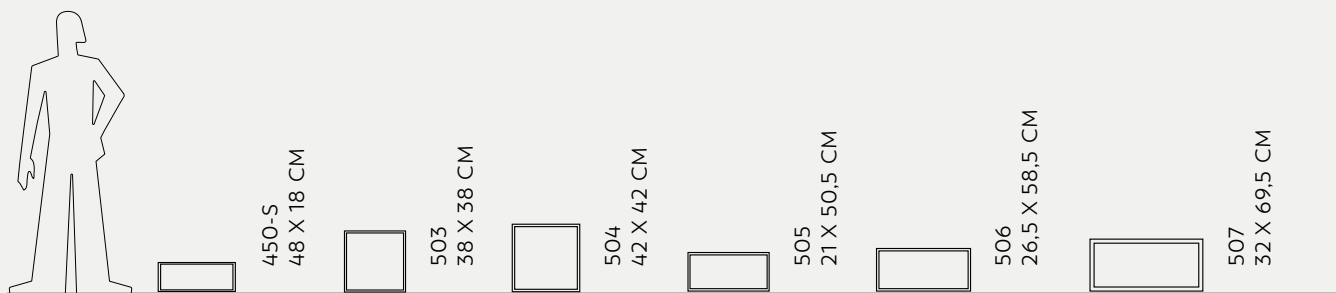

POTS - ITALIAN TRADITION

ROUND, SQUARE AND RECTANGULAR SAUCERS

Serralunga



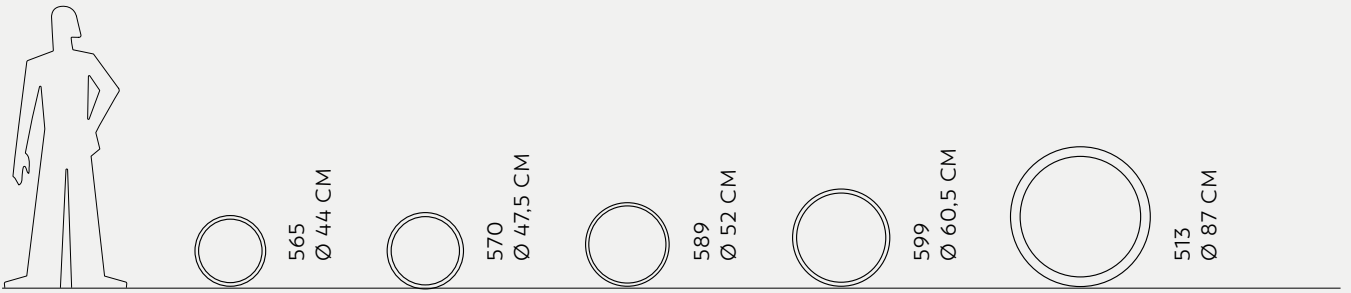
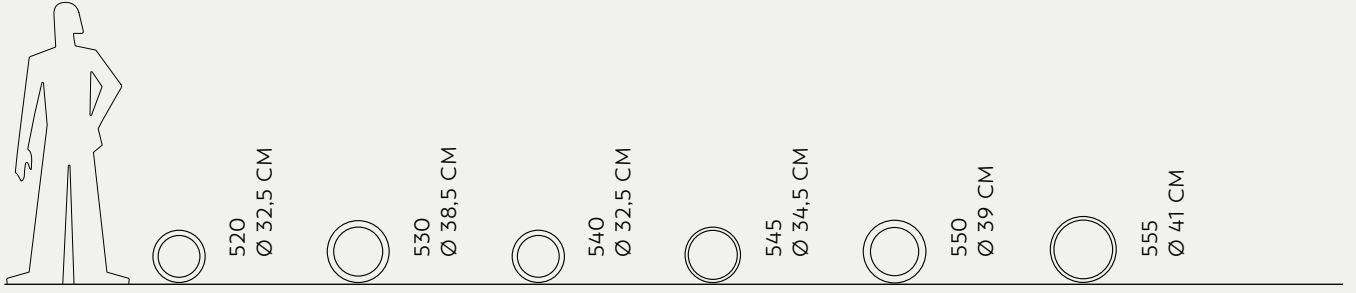



Square saucer



Round saucer



Rectangular saucer



Round saucer

TECHNICAL DETAILS

SISTEMA DI DRENAGGIO

WATER DRAINAGE SYSTEM

Tutti i vasi illuminati sono dotati di sistema di drenaggio per l'acqua. Rimuovere il tappo all'interno del vaso per far defluire l'acqua.

All illuminated pots are equipped with a water drainage system. Remove the inner stopper to drain water.

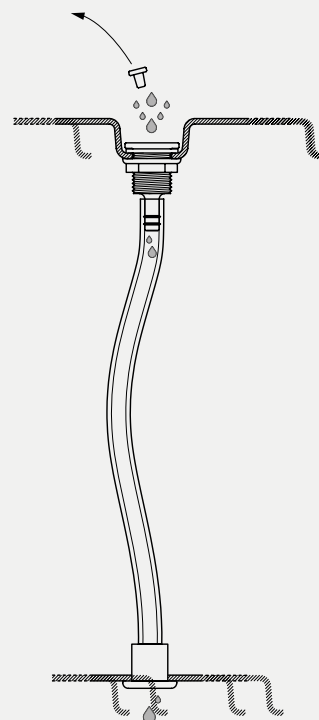

FISSAGGIO A TERRA

GROUND FIXING

I prodotti possono essere fissati a terra tramite piastre in acciaio inox AISI 316.

I tasselli per l'ancoraggio non sono inclusi nel kit, ma devono essere acquistati in base al tipo di pavimentazione su cui si desidera fissare il prodotto. Si consigliano 3 piastre per i vasi tondi e 2/4 piastre per i vasi quadrati e rettangolari.

Products can be fixed to the ground with AISI 316 stainless steel plates. Rawplugs are not included in this kit, they must be bought according to the ground where you want to fix the product. We suggest 3 plates for round pots and 2/4 plates for square and rectangular pots.

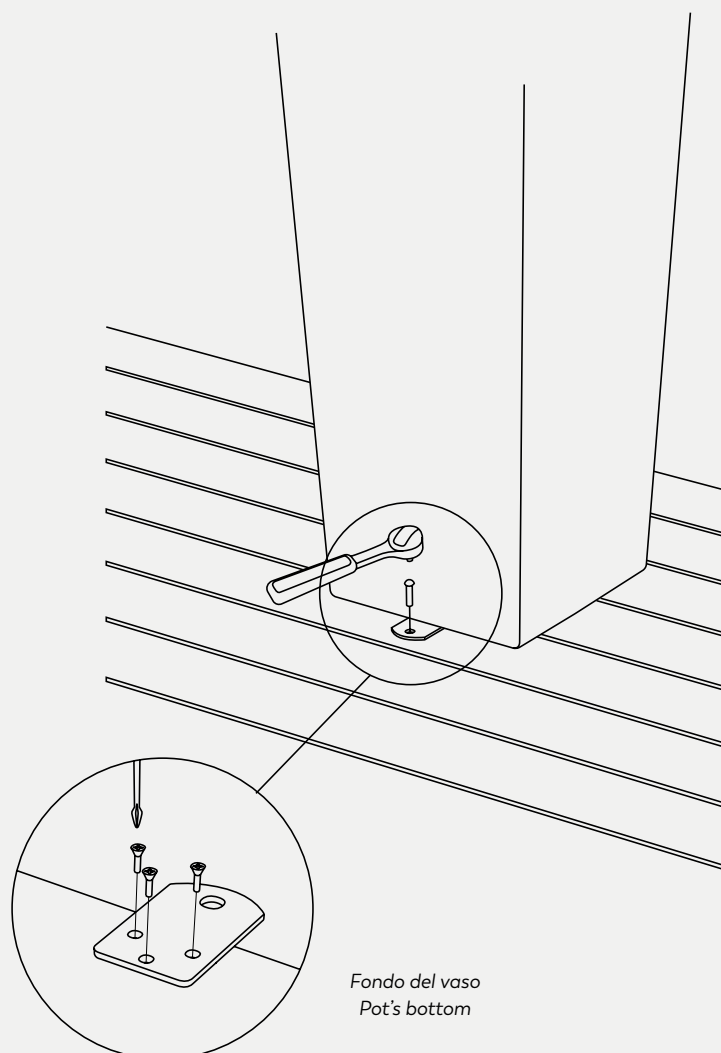

Fondo del vaso
Pot's bottom

ISTRUZIONI PER INVASATURA

POTTING INSTRUCTIONS

Interno

Riempire il vaso con 1/3 in altezza di argilla espansa, posizionare uno strato di tessuto drenante e completare il riempimento con terriccio idoneo per la pianta da invasare. L'argilla espansa svolge la funzione di riserva d'acqua, trattenendo l'umidità in eccesso e rilasciandola nel caso essa sia insufficiente.

Indoor

Fill the pot with 1/3 in height of expanded clay, put a draining cloth and complete filling with soil suitable for the plant to pot. Expanded clay has the function of water reservoir, holding excess wet and releasing it in case it is insufficient.

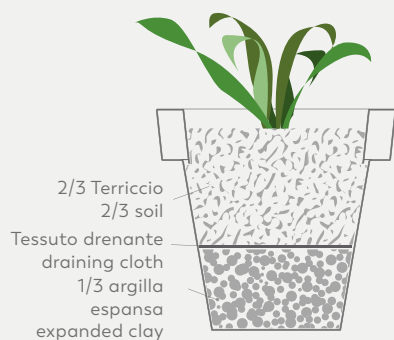

Portavaso

Infine i nostri vasi possono essere utilizzati come cachepot (portavaso). Sugeriamo l'utilizzo di un semplice vaso iniezione (plastica) con relativo sottovaso (opzionale).

Cachepot

Finally, our pots can be used like cachepot. We suggest the use of an injection pot with relative saucer (optional).



Outdoor

Il nostri vasi possono anche essere utilizzati come dei vasi di terracotta, praticando con un comune trapano un foro sul fondo del vaso (foratura Ø 6 mm circa). I vasi in doppia parete devono essere forati nella parte interna e sul fondo.

Outdoor

Our pots can be used like terracotta pots, drilling the bottom part (hole Ø about 6 mm). Double wall pots must be drilled in the inner and in the bottom part.

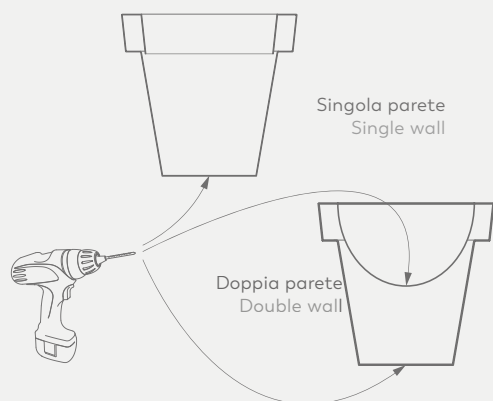

IMPIANTI LUCE

LIGHTING SYSTEMS

Impianto luce IP67 con lampadina a luce calda o luce fredda

LUCE FREDDA: Lampadina led 13 W (E27).
175/250 V (110/120 V) - 50/60 Hz - 1250 lm - 6000 K.
Cavo nero 3m.
Protezione IP67.
LUCE CALDA: Lampadina a risparmio energetico 20 W (E27).
220/240 V (110/120 V) - 50/60 Hz - 1200 lm - 2700 K.
Cavo nero 3m.
Protezione IP67.

IP67 lighting system with warm or cool white bulb

COOL WHITE: 13 W led bulb (E27).
175/250 V (110/120 V) - 50/60 Hz - 1250 lm - 6000 K.
3m black wire.
IP67 protection.
WARM WHITE: 20W energy saving bulb (E27).
220/240 V (110/120 V) - 50/60 Hz - 1200 lm - 2700 K.
3m black wire.
IP67 protection.

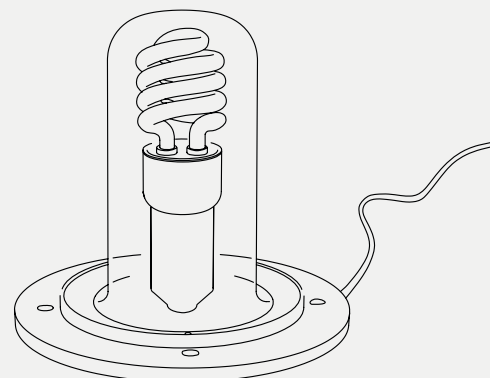

▽ ✕ □ CE UL IP67 CB

Impianto luce IP67 con lampadina led RGB

Lampadina led RGB 9 W (E27).
100/240 V - 50/60 Hz - 850 lm - 2700/6500 K - 16 milioni di colori selezionabili - pilotabile con telecomando a RF da 2.4 GHz -
3m black wire.
IP67 protection.

IP67 lighting system with RGB led bulb

9 W RGB led bulb (E27).
100/240 V - 50/60 Hz - 850 lm - 2700/6500 K - 16 millions color to choose - 2.4 GHz RF remote control -
3m black wire.
IP67 protection.

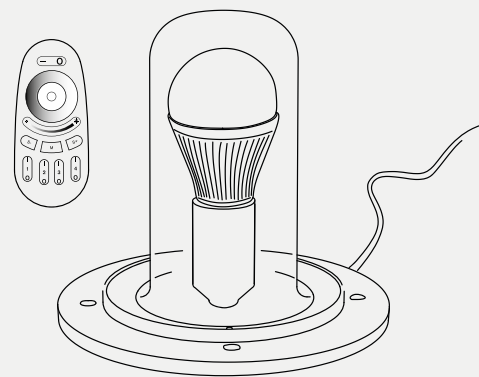

▽ ✕ □ CE UL IP67 CB

Protezione IP67

Protezione totale alla penetrazione di corpi solidi e polveri. Protezione contro l'immersione momentanea in acqua per 30 minuti ad 1 metro di profondità.

IP67 Protection

Total protection against solid corps and powders penetration. Protection against water immersion for 30 minutes at 1 meter deep.

Impianto luce led RGB wireless bluetooth IP68

1.2W led RGB - batteria agli ioni di litio da 3.7V, 2200 mAh - classe III
 Autonomia: fino a 8 ore alla massima luminosità
 Tempo di ricarica: fino a 6 ore.
 Stazione di ricarica per uso in interno: input 110/240V - 50/60 Hz - output 5VDC - Classe II
 Pilotabile con app da cellulare (connessa tramite bluetooth 4.0), oppure con pulsanti sul fondo dell'impianto.
 Protezione impianto luce IP68

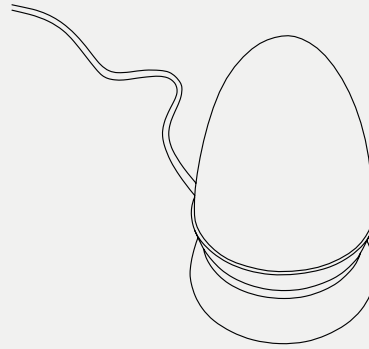

△ X CE FC IP68

IP68 RGB wireless bluetooth led lighting system

1.2W RGB led - 3.7V, 2200 mAh lithium-ion battery - class III.
 Battery life: up to 8 hours at maximum brightness.
 Recharging time: up to 6 hours.
 Charging station for indoor use: input 110/240V - 50/60 Hz - output 5VDC - Class II.
 Operated by mobile app (connected with bluetooth 4.0), or buttons on the bottom side of the lighting system.
 IP68 lighting system protection.

Impianto luce led RGB wireless IP52

2.04W led RGB - batteria agli ioni di litio da 3.7V, 1400 mAh - classe III
 Autonomia: fino a 10.5 ore alla massima luminosità.
 Tempo di ricarica: fino a 4.5 ore.
 Stazione di ricarica per uso in interno: input 100/240V - 50/60 Hz - output 6V - Classe III
 Pilotabile con con pulsanti sul fondo dell'impianto.
 Protezione impianto luce IP52

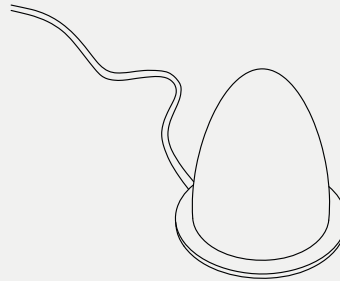

X CE E E IP52

Wireless IP52 RGB led lighting system

2.04W RGB led - 3.7V, 1400 mAh lithium-ion battery - class III
 Battery life: up to 10.5 hours at maximum brightness.
 Recharging time: up to 4.5 hours.
 Charging station for indoor use: input 100/240V - 50/60 Hz - output 6V - Class III
 Operated by buttons on the bottom side of the lighting system.
 IP52 lighting system protection.

Protezione IP68

Protezione totale alla penetrazione di corpi solidi e polveri. Protezione contro l'immersione permanente in acqua ad 1 metro di profondità.

IP68 Protection

Total protection against solid corps and powders penetration. Protection against permanent water immersion at 1 meter deep.

Protezione IP52

Protezione parziale alla penetrazione della polvere. Protezione dall'acqua che cade verticalmente dall'alto verso il basso.

IP52 Protection

Partial protection against dust penetration. Protection against water falling vertically from top to bottom.



COLORS, FABRICS & FINISHINGS

STANDARD COLOURS ☺



Bianco / WH



Neutro Luce / NT



Neve di San Candido / IWH

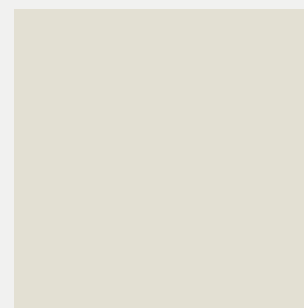

Gesso di Bologna / WH5



More di Rovo / BK



Pietra delle Dolomiti / GG

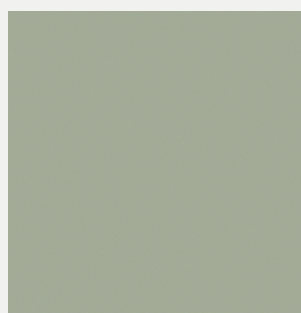

Salvia di Sardegna / SAV

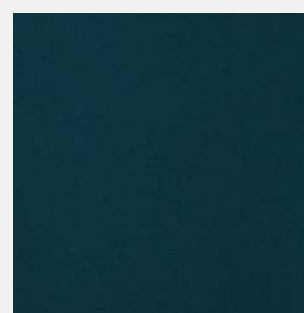

Verde Pavone / WP



Pietra di Matera / IV AV



Tortora di Torino / TO



Antracite di Sardegna / ANT



Origano di Sardegna / VMA

Eventuali disuniformità di colore sono legate al processo tecnologico ed alla finitura manuale dei prodotti:

● Colori studiati e appositamente prodotti nei laboratori interni Serralunga.

☺ Clean Fighter: Speciale miscela studiata da Serralunga per rendere più facile la pulizia di qualsiasi prodotto con colorazione standard.

* Irregular spatula finish not uniform

* Finitura spatolata non uniforme

STANDARD COLOURS ☺



Corallo / COL

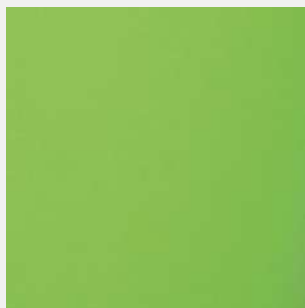

Apple Green / AG



Olive di Cerignola / VOC

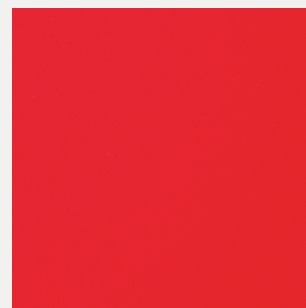

Rosso / RO

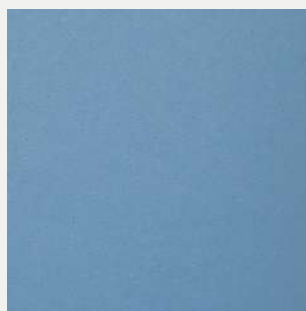

Acqua della Maddalena / AQM



Azzurro di Provenza / AZP



Blu di Portofino / BLP



Castoro / TC2



Terracotta scura / TC4

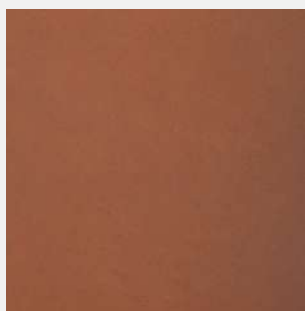

Terracotta Toscana / T



Impruneta classica / IMP*



Castagno / CA

Eventuali disuniformità di colore sono legate al processo tecnologico ed alla finitura manuale dei prodotti:

● Colori studiati e appositamente prodotti nei laboratori interni Serralunga.

☺ Clean Fighter: Speciale miscela studiata da Serralunga per rendere più facile la pulizia di qualsiasi prodotto con colorazione standard.

* Irregular spatula finish not uniform

* Finitura spatolata non uniforme

SPECIAL NUANCES ☺



Marmo / MAR

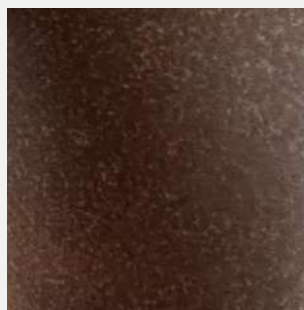

Corten / COR



RECYCLED ^{ECO} ♻️



Dalmata / DAL



Eco / ECO



Eventuali disuniformità di colore sono legate al processo tecnologico ed alla finitura manuale dei prodotti:

- Colori studiati e appositamente prodotti nei laboratori interni Serralunga.
- ☺ Clean Fighter: Speciale miscela studiata da Serralunga per rendere più facile la pulizia di qualsiasi prodotto con colorazione standard.

GLOSSY LACQUERED COLOURS



Bianco / LWH



Antracite / LAN



Nero / LBK



Rosso / LRO

MATT METALLIC LACQUERED



Azzurro / LAM



Rame / LCM



Sabbia / LSM

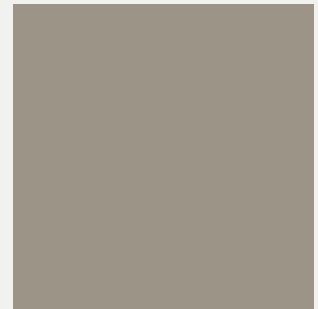

Titanio / LTM

GLOSSY METALLIC LACQUERED COLOURS



Argento / LCH



Oro / LGO

MOLESKIN FINISHING



Moleskin Grigio Man / MBK



Moleskin Rose / MTC



Moleskin Mediterraneo / WP



Moleskin Lime / MVO



MOLESKIN FINISHING

FABRICS



Half Moon / GREECE

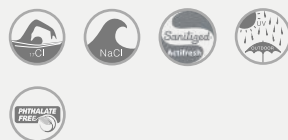

100% Polypropylene



Half Moon / WHITE

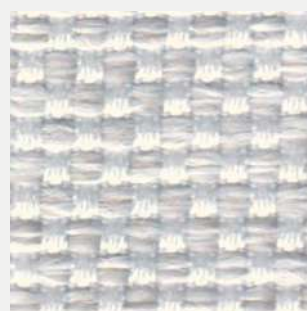

Half Moon / ICE

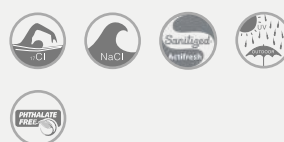

PP 58% PL 42%

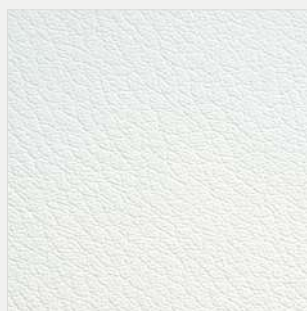

Sea / WHITE

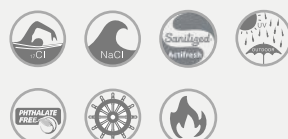

89% PVC
11% PA

FABRICS



Batyline / WHITE

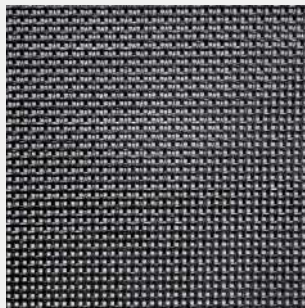

Batyline / BLACK

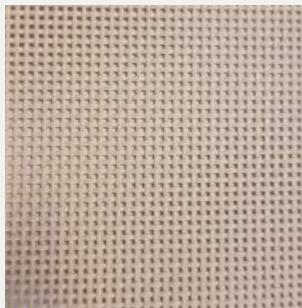

Batyline / DOVE

100% PVC coated polyester
mod. Lazy / mod. La Regista

LEGEND / LEGENDA



Chlorine resistant /
Resistente al cloro



Phthalate free /
Senza ftalati



Sea salt resistant /
Resistente al sale



IMO MED mod. B + D



Fungi and bacterial resistant /
Resistenza a funghi e batteri



Fire retardant /
Resistente al fuoco



Outdoor use suitable /
Adatto ad uso esterno



Medical use suitable /
Adatto ad uso medico

DOLCEVITA

SEAT /
SEDUTA

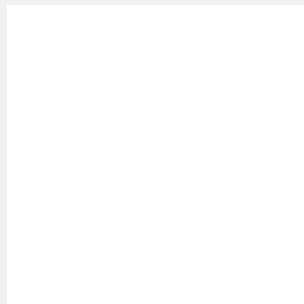

White Polyurethane

FRAME /
STRUTTURA

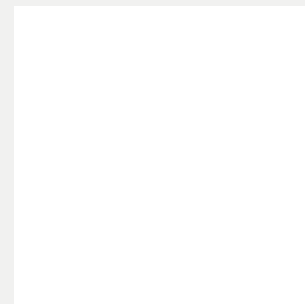

White

SOFA COVER

SOFA
COVERS /
COPRI
DIVANI

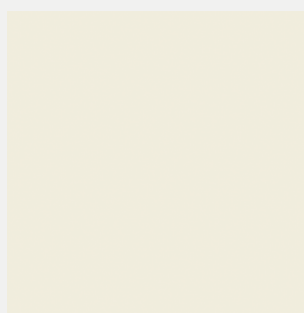

Beige

Poiana
20% polyuretane
80% polyester

IMBOTTITURA CUSCINO:
fibra PPT, poliuretano reticolato,
tessuto a maglia aperta.

Versione ignifuga classe 1IM su
richiesta.

CUSHION PADDING:
PPT fiber, crosslinked
polyurethane, mesh fabric.

Fire-retardant version 1IM class
upon request

FINITURE SUPERFICI

SURFACE FINISHINGS



 SMOOTH SURFACE



 SCRATCHED SURFACE



 GRANIGLIA SURFACE



 CASSERO SURFACE





 THE VASES SURFACE



 MEMORY POT SURFACE



 FINITURA PORCINO



1825 s.r.l. si riserva il diritto di apportare modifiche e miglioramenti ai prodotti illustrati in questo catalogo senza preavviso.

Possibili differenze tra i colori originali ed i colori delle immagini riportate in questo catalogo possono essere dovute alla tecnologia di stampa. I nostri uffici commerciali sono a completa disposizione per eventuali informazioni e chiarimenti.



1825 s.r.l. reserves the right to make changes and improvements to the products illustrated in this catalog without notice.

Possible differences between the original colors and the colors of the images shown in this catalog may be due to the printing technology. Our sales offices are at your full disposal for any information and clarifications.

SERRALUNGA

via Serralunga, 9 - 13900 Biella, Italy
ph.: +39 015 2435711
fax: +39 015 31081
info@serralunga.com

