

SERRALUNGA

MADE IN ITALY

Since 1825

2000
YEARS

GIFTS

SERRALUNGA
MADE IN ITALY

Since 1825
200
YEARS

GIFTS

INDEX

SERRALUNGA	4
DESIGNERS	12
GIFTS	10
BINGO	14
BONNIE	16
CACTUS	18
CAPITELLO <i>NEW</i>	20
CERO	22
DOG'SPALACE <i>NEW</i>	24
DOGGY <i>NEW</i>	26 ^{39, 58}
FIORE DI LOTO	30 ⁴⁷
FLAME	34
GATT-ONE <i>NEW</i>	36 ²⁸
GIANO	40
HONEY	42
JUJU	46 ²³
LOUNGE CUBE	50 ²⁹
NEW-WAVE-S	54
OTTO	56 ^{28, 29}
PALOMA E PULCINO	60 ^{27, 29}
PLOMB	66
PORCINO	68
SKAL	72
TECHNICAL DETAILS	74
COLOURS & FABRICS	80

MADE IN ITALY
SINCE 1825

100%
RECYCLABLE



THE FIRST ONES
PRODUCING
VASES WITH
ROTATIONAL
MOULDING IN
ITALY



SERRA

46 DESIGNERS



250 TYPES
OF VASES
FROM ITALIAN
TRADITION TO
INTERNATIONAL
DESIGN

2025
ANNIVERSARY
200 YEARS
ABOUT
FONDATION

THE FIRST ONES
PRODUCING
BIG VASES
OF FAMOUS
DESIGNERS



THE WORLDWIDE
BIGGEST VASE IN
COLLECTION



THE FIRST ONES
MAKING LIGHTED
VASES

LUNGA

1000

SQUARE
METERS OF
PHOTOVOLTAIC
AREA



“WE CONSIDER PLASTIC A PRECIOUS MATERIAL AND IT SHOULD BE USED CAREFULLY ONLY WHEN IT MAKES SENSE”

OUR PRODUCTS ARE REUSABLE UNLIMITED TIMES
100% RECYCLABLE

Most of our products are mainly made of 100% mono material: linear low density polyethylene LLDPE resin by rotational molding process. Polyethylene is a 100% recyclable polymer. Consequently, SERRALUNGA products are 100% recyclable and have a long life (over 10 years).

SERRALUNGA uses mainly LLDPE, 100% recyclable and some of our colours are made with recycled materials. As a result our products are reusable unlimited times. The material and its production process makes the products very resistant to extreme temperatures (-35 °C/+ 80°C; -31°F/+176°F), shocks, UV rays and saline climates.

THE CYCLE OF TRANSFORMATION
A VIRTUOUS CIRCULAR ECONOMY

At the end of their life, our objects can be transformed into plastic powder to give new life to other objects, for “a virtuous circular economy”.

The rotational molding process allows to operate at low temperature and in absence of pressure. Then, a non-forced air cooling completes the production process. Consequently the cycle of transformation is very long, if compared to other moulding technologies, it takes approx. 30 minutes to produce one piece. In this way, the material doesn't undergo thermal shocks due to high temperatures, or physical shocks due to strong cooling and short production cycles. For these reasons a simple polymer such as LLDPE has physical characteristics of high strength, elasticity and durability.





CONSCIOUS PRODUCTION **A CONTINUOUS PROCESS**

SERRALUNGA uses only raw material transformed in Italy and certificated as per EU legislations. This has a positive impact also on the transport: it allows us to produce lower CO2 emissions.

We recycle our discarded products internally. We have started to use more and more second life LLDPE raw material containing 30% to 70% of regenerated material, without reducing or penalizing the quality and resistance of our objects.

The entire production process is made in SERRALUNGA factory located in Biella (North of Italy). Our production plant is equipped with PHOTOVOLTAIC PANELS that reduce energy consumption to the minimum respecting the environmental Ethics.

SUSTAINABLE - No polluting solvents are employed during the production process

ECOLOGICAL - They are obtained with inert and recyclable raw materials

LONG LASTING - Resistant, Long lasting, Excellent value for money

WEATHER RESISTANT - Products made of polyethylene (LLDPE) by roto molding bear sudden thermal excursions from -35 °C to +80 °C / -31°F/+176°F. Robust and shock resistant.

LIGHT WEIGHT - Easy to handle

MINIMAL MAINTENANCE - Can be cleaned quickly and easily

DESIGNERS



Eero Aarnio



Aquilalberg



Ron Arad



Alessandra Baldereschi



Bazzicalupo - Mangiarotti



Claudio Bellini



Sebastian Bergne



Luisa Bocchietto



Bortolani - Righi



Michel Boucquillon



Calvi - Brambilla



Aldo Cibic



Florent Coirier



Carlo Colombo



Michele De Lucchi



Rodolfo Dordoni



Marta Daza Fernandez



Naoto Fukasawa



Joan Gaspar



Giovanni Jacobone



Zaha Hadid



Arik Levy



Lineeverdi



Ross Lovegrove



Vico Magistretti



Raffaella Mangiarotti



Jean-Marie Massaud



Alberto Meda



Philippe Nigro



Patrick Norguet



Karim Rashid



Christophe Pillet



Patrizia Pozzi



Andrée e Olivia Putman



Lina Obregon



Paolo Rizzatto



Marc Sadler



Marta Sansoni



Denis Santachiara



Ettore Sottsass



Garth Roberts



Massimo Roj



Philippe Starck



Brian Steendyk



Patricia Urquiola



Ionna Vautrin



ZPZ Partners



GIFTS



BINGO
pag. 14



BONNIE
pag. 16



CACTUS
pag. 18



CAPITELLO NEW
pag. 20



CERO
pag. 22



DOG'S PALACE NEW
pag. 24



DOGGY NEW
pag. 26

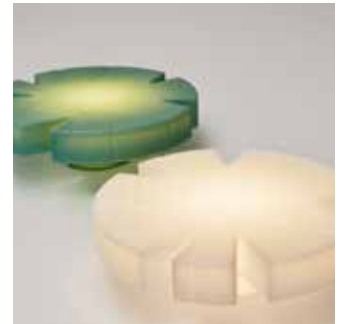

FIORE DI LOTO
pag. 30



FLAME
pag. 34



GATT-ONE NEW
pag. 36



GIANO
pag. 40



HONEY
pag. 42



JUJU
pag. 46



LOUNGE CUBE
pag. 50



NEW-WAVE-S
pag. 54



OTTO
pag. 56



PALOMA E PULCINO
pag. 60



PLOMB
pag. 66



PORCINO
pag. 68



SKAL
pag.72

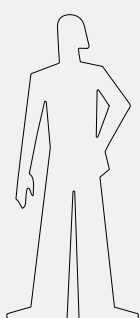

01

BINGO
23/35 X 8 X 45 CM

GIFTS

BINGO

Marta Daza Fernandez



18



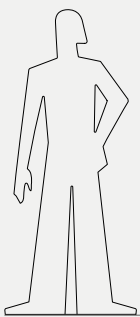

BONNIE
BONNIE WITH LIGHT ✨
40 X 22 X 27 CM

✨ AVAILABLE WITH LIGHT

GIFTS

BONNIE

Alessandra Baldereschi







☼ AVAILABLE WITH LIGHT

GIFTS

CACTUS

Alessandra Baldereschi





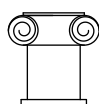
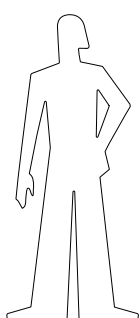

CAPITELLO
48 X 44 X 48 CM

GIFTS

CAPITELLO NEW

Serralunga





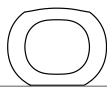
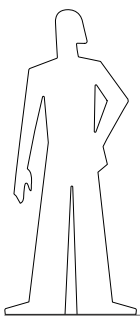

CERO
58 X 40 X 45 CM



MOLESKIN FINISHING AVAILABLE
(only on the external part)

GIFTS

CERO

Brian Steendyk





Cero, Juju and Pic Nic - MVO Moleskin finishing

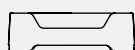
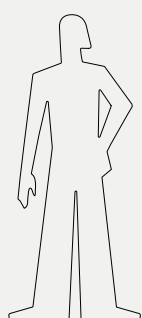

DOGS/P
67 X 47 X 20 CM

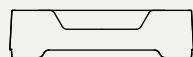

DOGS/C
97 X 67 X 25 CM

GIFTS

DOG'S PALACE NEW





Dog's Palace - TC4

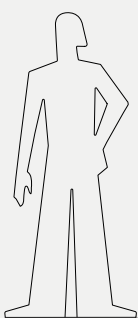

DOGGY
60 X 27.5 X 55 CM

GIFTS

DOGGY NEW

Eero Aarnio

☼ AVAILABLE WITH LIGHT



MOLESKIN FINISHING AVAILABLE



ECO FRIENDLY FINISHING AVAILABLE





*Doggy - IWH/BK ECO
Pulcino - BK/IWH ECO*



Doggy - NT with light



*Doggy - TO
Otto - AV
Gatt-one - WH*



*Doggy - MTC Moleskin Finishing
Otto - MAN Moleskin Finishing
Pulcino - MVO Moleskin Finishing
Longue Cube - MWP Moleskin Finishing*

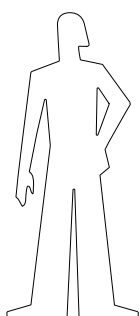

FIORE DI LOTO
Ø 45 X 14 CM

GIFTS

FIORE DI LOTO

Marta Sansoni





Fiore di Loto - NT with light
Ruffle - NT with light



Fiore di Loto - NT with light



Fiore di Loto - NT

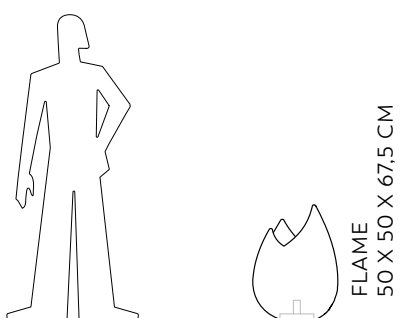

GIFTS

FLAME

Sebastian Bergne





Flame - NT

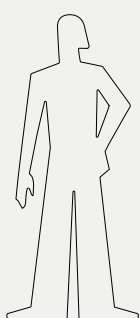

GATT-ONE
34 X 14 X 50 CM

 MOLESKIN FINISHING AVAILABLE

GIFTS

GATT-ONE NEW







Gatt-one - MAN moleskin finishing



Gatt-one - WH
Doggy - TO

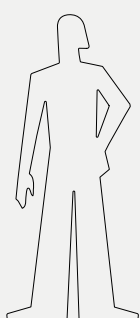

GIANO
Ø32 X 60 CM

GIFTS

GIANO

Luisa Bocchietto





Ciano - LWH lacquered finishing

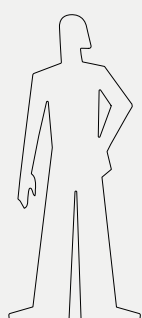

HONEY
Ø24 X 31 CM

☞ AVAILABLE WITH LIGHT

GIFTS

HONEY

Raffaella Mangiarotti





Honey - NT





Honey - NT



FURNITURE
CATEGORY

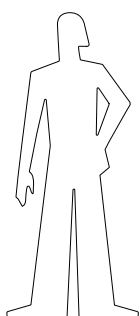

JUJU
JUJU WITH LIGHT ✨
Ø52 X 50 CM



✨ AVAILABLE WITH LIGHT
MOLESKIN FINISHING AVAILABLE

GIFTS

JUJU

Garth Roberts





Juju - MGS Moleskin finishing
Pinebeach sofà - MGS Moleskin finishing
Fiore di Loto - NT



Juju table - GG
Pine Beach armchair - GG



Juju - WH
Pine Beach sofa - WH

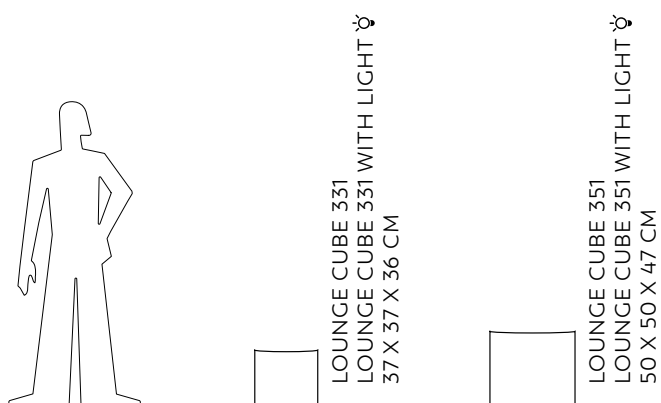

✨ AVAILABLE WITH LIGHT
MOLESKIN FINISHING AVAILABLE

GIFTS

LOUNGE CUBE

Serralunga





Lounge Cube - MAN Moleskin finishing
Aqua - WH and MWP Moleskin finishing

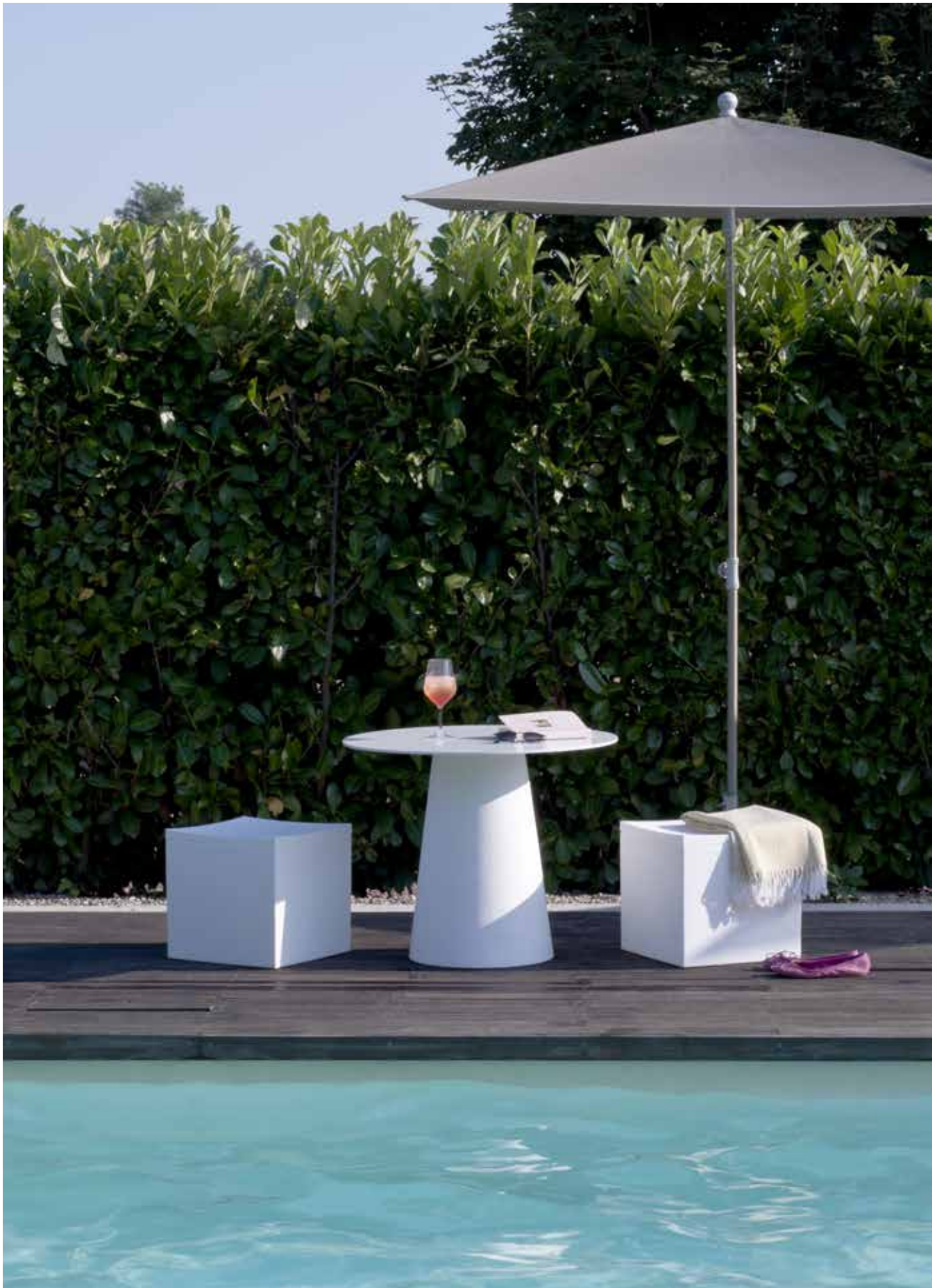

Longue Cube - IWH



Lounge Cube GS and Fence 715

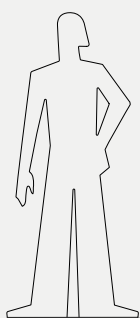

NEW-WAVE-S
Ø 15 X 18 CM

GIFTS

NEW-WAVE-S

Serralunga





New wave-s - LWH and LTO lacquered finishing

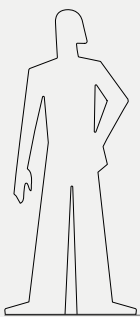

OTTO
OTTO WITH LIGHT ✨
66 X 17.5 X 38 CM



✨ AVAILABLE WITH LIGHT
MOLESKIN FINISHING AVAILABLE

GIFTS

OTTO

Alessandra Baldereschi







Doggy - MTC Moleskin Finishing
Otto - MAN Moleskin Finishing



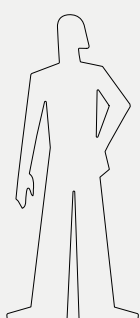

PALOMA
PALOMA WITH LIGHT ☽
130 X 37,5 X 52,5 CM



PULCINO
PULCINO WITH LIGHT ☽
80 X 27 X 39 CM

GIFTS

PALOMA E PULCINO

Eero Aarnio

☽ AVAILABLE WITH LIGHT



MOLESKIN FINISHING AVAILABLE ONLY FOR PULCINO



ECO FRIENDLY FINISHING AVAILABLE





Paloma - NT





Paloma - NT- WH and AQM



Paloma AQM and Pulcino RO

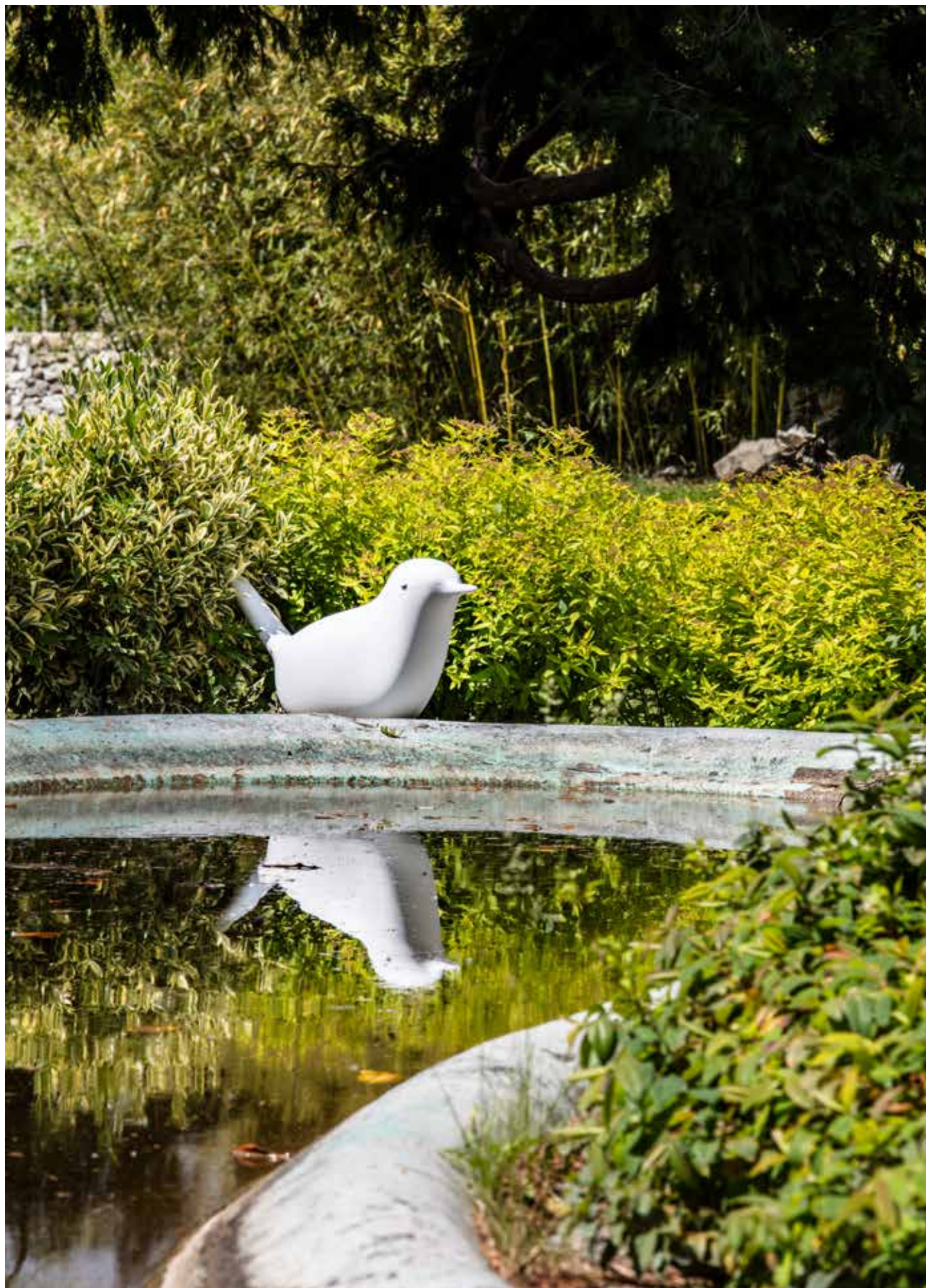

Pulcino WH5

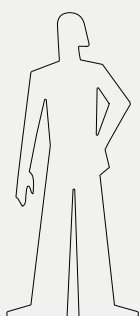

PLOMB
45 X 45 X 60 CM

GIFTS

PLOMB

Karim Rashid





Plomb - GG

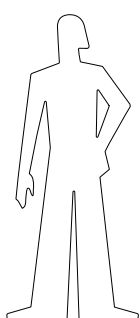

PORCINO
PORCINO WITH LIGHT ✂
PORCINO ASHTRAY ⌀
35 X 35 X 50 CM

GIFTS

PORCINO

Aldo Cibic

✂ AVAILABLE WITH LIGHT
⌀ ASHTRAY



MOLESKIN FINISHING AVAILABLE



PORCINO FINISHING





Porcino - NT with light





Parcino -AZP, VB and GS
Lou Lou table - ANT with Lavagna top

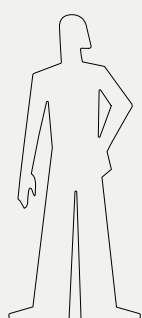

SKAL ROUND
Ø 29 X 31 CM



SKAL SQUARE
25 X 23 X 28,5 CM

GIFTS

SKAL

Serralunga





Skall - WH, AQM, and AZP

TECHNICAL DETAILS

MATERIALE ANTIFIAMMA UL94-V2

FLAME RETARDANT MATERIAL UL94-V2

Su richiesta possiamo utilizzare materiale LLDPE addizionato con ritardante di fiamma. In questo caso il materiale è classificato V-2 in accordo con la normativa UL-94 dei test di infiammabilità.

Non tutti i prodotti sono fornibili con materiale UL94-V2, contattate il nostro ufficio commerciale per maggiori informazioni, prezzo e disponibilità.

Only on request we can use LLDPE material with added flame retardant.

In this case the material is classified V-2 in accordance with the UL-94 flammability test standard.

Not all items can be produced with UL94-V2 material, please contact our sales department for more information, price and availability.

SISTEMA DI DRENAGGIO

WATER DRAINAGE SYSTEM

Tutti i vasi illuminati sono dotati di sistema di drenaggio per l'acqua. Rimuovere il tappo all'interno del vaso per far defluire l'acqua.

All illuminated pots are equipped with a water drainage system. Remove the inner stopper to drain water.

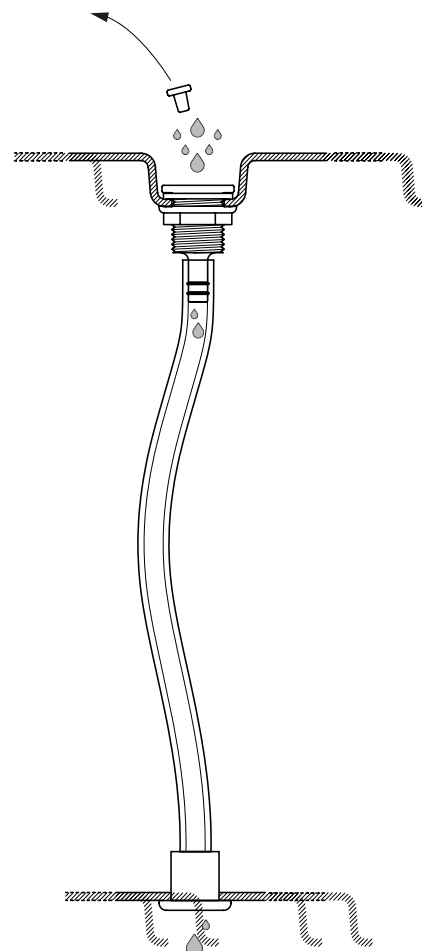

FISSAGGIO A TERRA GROUND FIXING

I prodotti possono essere fissati a terra tramite piastre in acciaio inox AISI 316.

I tasselli per l'ancoraggio non sono inclusi nel kit, ma devono essere acquistati in base al tipo di pavimentazione su cui si desidera fissare il prodotto. Si consigliano 3 piastre per i vasi tondi e 2/4 piastre per i vasi quadrati e rettangolari.

Products can be fixed to the ground with AISI 316 stainless steel plates. Rawplugs are not included in this kit, they must be bought according to the ground where you want to fix the product. We suggest 3 plates for round pots and 2/4 plates for square and rectangular pots.

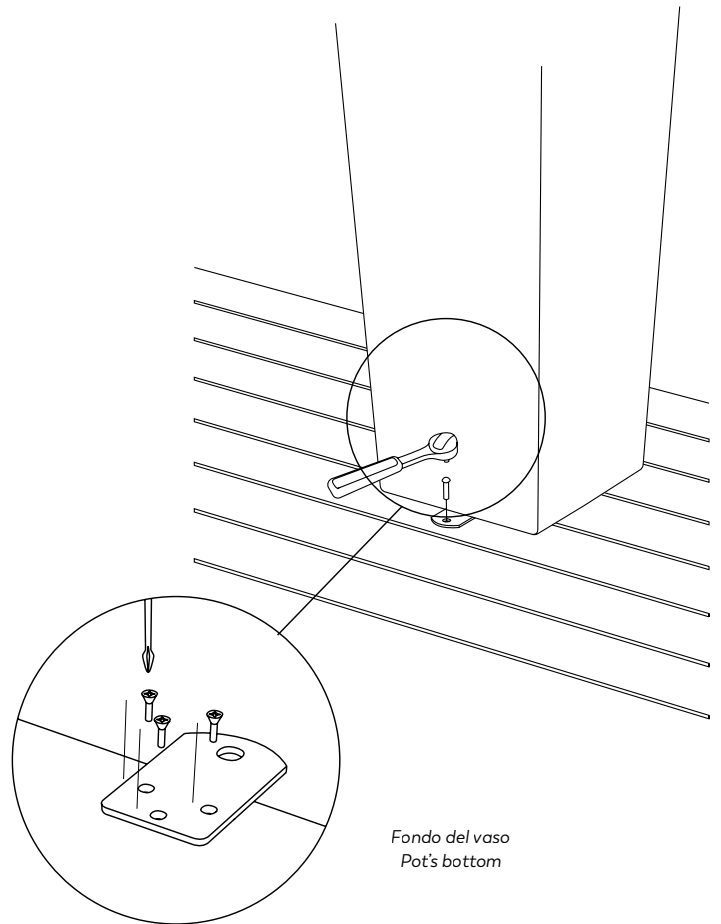

FISSAGGIO MARCANTONIO AU MUR E POT AU MUR MARCANTONIO AU MUR AND POT AU MUR WALL FIXING

Il vaso viene fornito con due ganci in acciaio inox AISI 316. È resistente agli agenti atmosferici, al cloro, anticorrosione, adatto in ambiente salino. Tasselli a muro non compresi. Acquistate i tasselli più adatti al tipo di muro su cui andrete a fissare il vaso (mattoni forati, calcestruzzo, cartongesso, etc.).

The pot is provided with a hook in stainless steel AISI 316. It's resistant to weather, chlorine, corrosion and suitable in saline environment.

Nogs not included. Buy the nogs suited for the type of wall on which you are going to fix the pot (bricks, concrete, plasterboard, etc.).

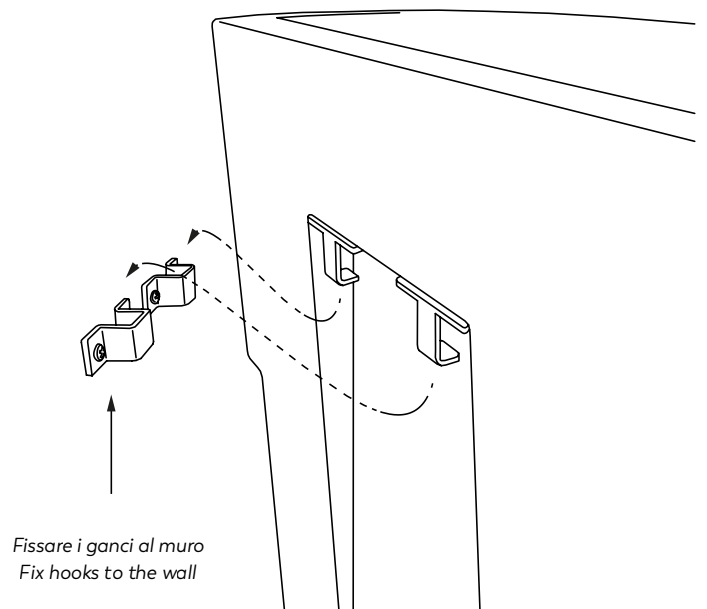

ISTRUZIONI PER INVASATURA

POTTING INSTRUCTIONS

Riempimento vaso

Riempire il vaso con 1/3 in altezza di argilla espansa, posizionare uno strato di tessuto drenante e completare il riempimento con terriccio alleggerito per giardini pensili fino a qualche cm dal bordo del contenitore interno. Attenzione, l'uso esclusivo di terra è sconsigliato perchè si compatta, non drena ed appesantisce oltre il consentito la struttura con rischio di danneggiare il vaso. L'argilla espansa svolge la funzione di riserva d'acqua, trattenendo l'umidità in eccesso e rilasciandola nel caso essa sia insufficiente.

Potting instructions

Fill the pot with 1/3 in height of expanded clay, put a draining cloth and complete filling with green roof lightweight soil, leaving 5 cm from the pot rim. Warning, the exclusive use of ordinary soil is not recommended, as it does not drain well and weigh down the structure beyond the permitted with risk of damaging the pot. Expanded clay has the function of water reservoir, holding excess wet and releasing it in case it is insufficient.

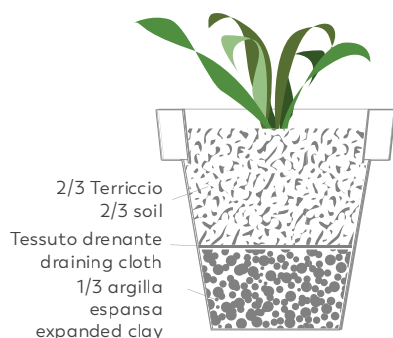

Portavaso

Infine i nostri vasi possono essere utilizzati come cachepot (portavaso). Sugeriamo l'utilizzo di un semplice vaso iniezione (plastica) con relativo sottovaso (opzionale).

Nel caso in cui il vaso sia provvisto di kit per il drenaggio dell'acqua, non rimuovere il tappino in PVC.

Cachepot

Finally, our pots can be used like cachepot. We suggest the use of an injection pot with relative saucer (optional).

In case that the drainage kit has already been mounted, don't remove the PVC stopper.

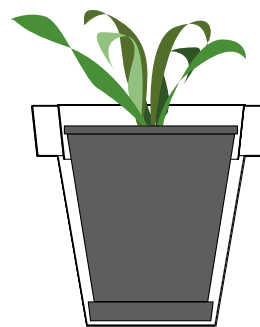

Interno

Procedere con l'invasatura senza forare il prodotto e, nel caso sia presente il kit di drenaggio dell'acqua, senza rimuovere il tappino in PVC dall'interno dell'alloggiamento

Indoor

Proceed with the potting without drilling the product and, if there is a water drainage kit, without removing the PVC stopper

Esterno

I nostri vasi possono anche essere utilizzati come dei vasi di terracotta, praticando con un comune trapano dei fori sul fondo del vaso (foratura Ø 6 mm circa). Per i vasi a doppia parete, nel caso sia presente il kit di drenaggio, va rimosso il tappo prima dell'invasatura, mentre se non sono muniti di kit di drenaggio, va forata sia la vasca interna che il fondo.

Outdoor

Our pots can also be used like terracotta pots, making holes with a common drill on the bottom of the pot (hole Ø 6 mm). If double-wall pots, have drainage kit, the cap must be removed before planting.

In case double-wall pots are not equipped with drainage kit, both the inner tank and the bottom must be drilled.

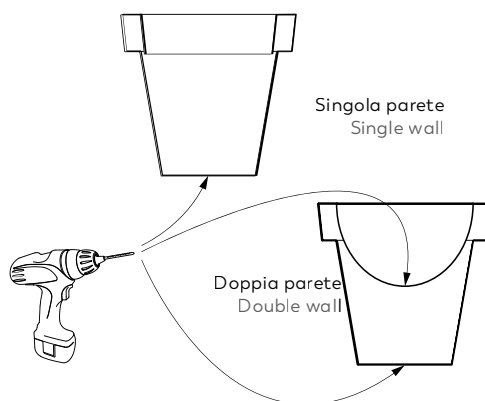

IMPIANTI LUCE

LIGHTING SYSTEMS

Impianto luce IP67 con lampadina a luce calda o luce fredda

LUCE FREDDA: Lampadina led 13 W (E27).
175/250 V (110/120 V) - 50/60 Hz - 1250 lm - 6000 K.
Cavo nero 3m.
Protezione IP67.
LUCE CALDA: Lampadina a risparmio energetico
20 W (E27).
220/240 V (110/120 V) - 50/60 Hz - 1200 lm - 2700 K.
Cavo nero 3m.
Protezione IP67.

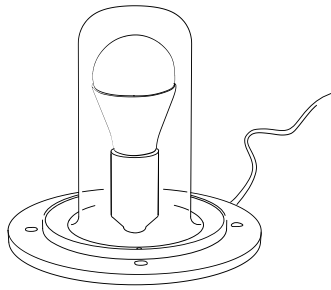

IP67 CB

IP67 lighting system with warm or cool white bulb

COOL WHITE: 13 W led bulb (E27).
175/250 V (110/120 V) - 50/60 Hz - 1250 lm - 6000 K.
3m black wire.
IP67 protection.
WARM WHITE: 20W energy saving bulb (E27).
220/240 V (110/120 V) - 50/60 Hz - 1200 lm - 2700 K.
3m black wire.
IP67 protection.

Impianto luce IP67 con lampadina led RGB

Lampadina led RGB 9 W (E27).
100/240 V - 50/60 Hz - 960 lm - 2700/6500 K
16 milioni di colori selezionabili
pilotabile con telecomando a RF da 2.4 GHz -
3m black wire.
IP67 protection.

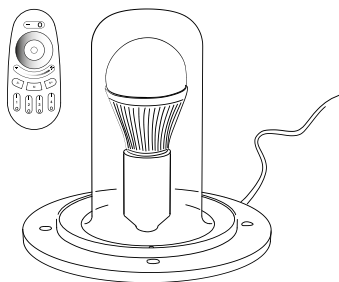

IP67 CB

IP67 lighting system with RGB led bulb

9 W RGB led bulb (E27).
100/240 V - 50/60 Hz - 960 lm - 2700/6500 K -
16 millions color to choose
2.4 GHz RF remote control
3m black wire.
IP67 protection.

Impianto luce led wireless IP67

3W led, 3000K, 290 lm, batteria agli ioni di litio da
5200 mAh, classe III
Autonomia: più di 6 ore alla massima luminosità.
Tempo di ricarica: fino a 10 ore.
Stazione di ricarica a induzione (per uso interno) fun-
ziona con caricatore (non incluso) 5V-1A o 5V-2A con
cavo con uscita USB.
Led pilotabile con tasto sul fondo.
Protezione impianto luce IP67

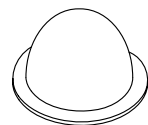

IP67

Wireless IP67 led lighting system

3W led, 3000K, 290 lm, 5200 mAh lythium battery,
class III
Battery life: up to 6 hours at maximum brightness.
Recharging time: up to 10 hours.
Induction charging station (for indoor use) works
with 5V -1A or 5V-2A charger connected by wire
with USB connector.
Operated by button on the bottom side of the
lighting system.
IP67 lighting system protection.

Protezione IP67

Protezione totale alla penetrazione di corpi solidi e polveri.
Protezione contro l'immersione momentanea in acqua per
30 minuti ad 1 metro di profondità.

IP67 Protection

Total protection against solid corps and powders penetra-
tion. Protection against water immersion for 30 minutes
at 1 meter deep.

Impianto luce led RGBW wireless IP65

1,6 W RGBW wireless led (bianco 3000K) - 170lm - batteria

agli ioni di litio da 2000 mAh - Classe II.

Autonomia: Circa 6 ore alla massima luminosità (luce statica).

Tempo di ricarica: Fino a 3 ore.

Caricabatterie con cavo per uso interno (incluso):

- Input 110-240V - 50/60Hz.

- Output 5V-1A.

Led pilotabile con tasto sul fondo o con apposito telecomando

RF (incluso).

Protezione impianto luce IP65

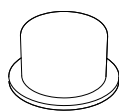

    IP65

Wireless IP65 RGBW led lighting system

1,6W RGBW wireless led (3000K white) - 170 lm - 2000 mAh lithium battery - Class II.

Battery life: Approximately 6 hours at maximum brightness (static mode).

Recharging time: up to 3 hours.

Charger with cable for indoor use (included):

- Input 110-240V - 50/60Hz.

- Output 5V-1A.

Operated by button on the bottom side of the lighting system or RF remote control (included).

IP65 lighting system protection.

Impianto luce led RGB wireless bluetooth IP68

1.2W led RGB, 120 lm, batteria agli ioni di litio da 3.7V, 2200 mAh - classe III

Autonomia: fino a 8 ore alla massima luminosità

Tempo di ricarica: fino a 6 ore.

Stazione di ricarica per uso in interno: input 110/240V - 50/60 Hz - output 5VDC - Classe II

Pilotabile con app da cellulare (connessa tramite bluetooth 4.0), oppure con pulsanti sul fondo dell'impianto.

Protezione impianto luce IP68

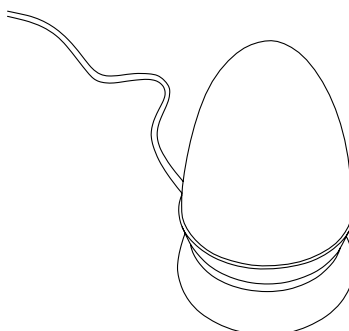

    IP68

IP68 RGB wireless bluetooth led lighting system

1.2W RGB led, 120 lm, 3.7V 2200 mAh lithium-ion battery - class III.

Battery life: up to 8 hours at maximum brightness.

Recharging time: up to 6 hours.

Charging station for indoor use: input 110/240V - 50/60 Hz - output 5VDC - Class II.

Operated by mobile app (connected with bluetooth 4.0), or buttons on the bottom side of the lighting system.

IP68 lighting system protection.

Protezione IP65

Protezione totale alla penetrazione di corpi solidi e polveri.
Protezione contro getti di acqua.

IP65 Protection

Total protection against solid corps and powders penetration.
Protection against low-pressure water jets.

Protezione IP68

Protezione totale alla penetrazione di corpi solidi e polveri.
Protezione contro l'immersione permanente in acqua ad 1 metro di profondità.

IP68 Protection

Total protection against solid corps and powders penetration.
Protection against permanent water immersion at 1 meter deep.

Protezione IP20

Protezione contro oggetti solidi più grandi di 12.5 mm.
Nessuna protezione contro i liquidi.

IP20 Protection

Protection against solid corps bigger than 12.5 mm.
No protection against liquid.



COLOURS & FABRICS

STANDARD COLOURS ☺

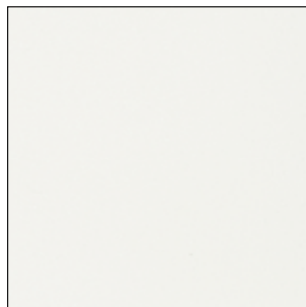

Bianco / WH
(bianco panna/creamy white)



Neutro Luce / NT
(traslucido/translucent)

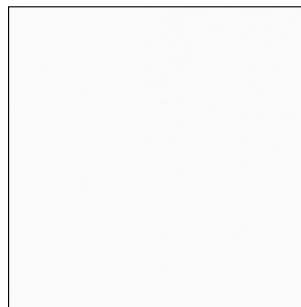

Neve di San Candido / IWH
(bianco ghiaccio/ice white)

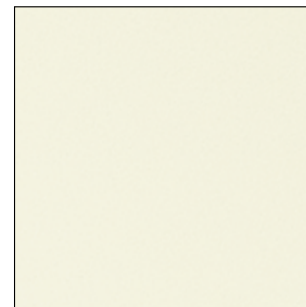

Gesso di Bologna / WH5
(bianco gesso/chalk white)

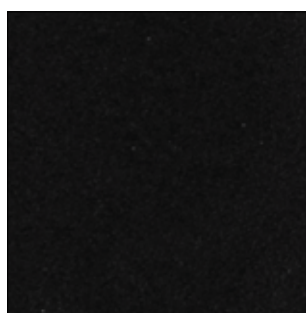

More di Rovo / BK
(nero/black)



Pietra delle Dolomiti / GG
(grigio chiaro/light grey)



Salvia di Sardegna / SAV
(verde salvia/sage green)



Verde Pavone / WP
(petrolio/peacock green)

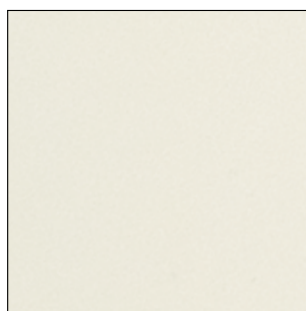

Pietra di Matera / AV
(avorio/ivory)



Tortora di Torino / TO
(tortora/dove)

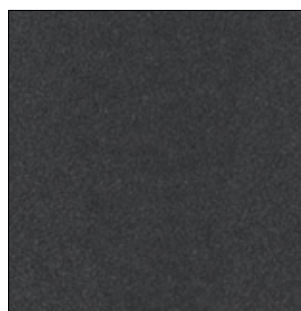

Antracite di Sardegna / ANT
(antracite/anthracite)



Origano di Sardegna / VMA
(verde/marrone brown/green)

Eventuali disuniformità di colore sono legate al processo tecnologico ed alla finitura manuale dei prodotti:

- Colori studiati e appositamente prodotti nei laboratori interni Serralunga.
- ☺ Clean Fighter: Speciale miscela studiata da Serralunga per rendere più facile la pulizia di qualsiasi prodotto con colorazione standard.
- ⊘ Non Clean Fighter

Eventual colour discrepancies are linked to the technological process and to the manual finishing of the products:

- Colours are studied and properly realized in Serralunga's laboratories.
- ☺ Clean Fighter. Special mixture studied by Serralunga to make the cleaning of products in standard finish, easier.
- ⊘ Non Clean Fighter

* Irregular spatula finish not uniform
* Finitura spatolata non uniforme

STANDARD COLOURS ☺



Red Clay / RCL

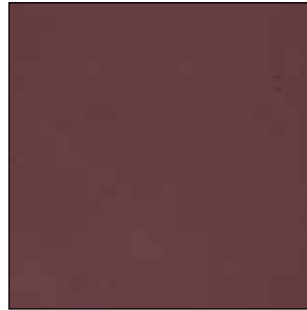

Rosso Pompeiano / PR
(vinaccia/bordeaux)



Olive di Cerignola / VOC
(verde oliva/ olive green)



Rosso / RO
(rosso vivo/ bright red)



Acqua della Maddalena / AQM
(blu acciaio/ steel blue)



Azzurro di Provenza / AZP
(azzurro chiaro/ pale blue)



Verde British / VB
(verde pino/ pine green)



Castoro / TC2
(marroncino chiaro/ light brown)



Terracotta scura / TC4
(cioccolato/ chocolate)



Terracotta Toscana / T



Impruneta classica / IMP*



Giallo Sahara / GS
(giallo senape/ mustard yellow)

Eventuali disuniformità di colore sono legate al processo tecnologico ed alla finitura manuale dei prodotti:

- Colori studiati e appositamente prodotti nei laboratori interni Serralunga.
- ☺ Clean Fighter: Speciale miscela studiata da Serralunga per rendere più facile la pulizia di qualsiasi prodotto con colorazione standard.
- ⊘ Non Clean Fighter

Eventual colour discrepancies are linked to the technological process and to the manual finishing of the products:

- Colours are studied and properly realized in Serralunga's laboratories.
- ☺ Clean Fighter. Special mixture studied by Serralunga to make the cleaning of products in standard finish, easier.
- ⊘ Non Clean Fighter

* Irregular spatula finish not uniform
* Finitura spatolata non uniforme

SPECIAL NUANCE

RECYCLED



Corten / COR

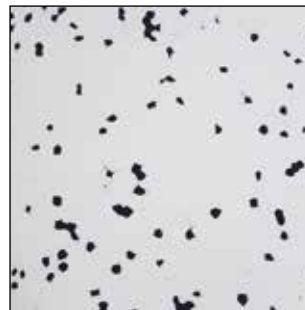

Dalmata / DAL



Eco / ECO



SLEEKY



Verde British / LVB
(verde pino / pine green)



Giallo Sahara / LGS
(giallo senape/ mustard yellow)



Salvia di Sardegna / LSA
(verde salvia/sage green)



Acqua della Maddalena / LAQ
(blu acciaio/ steel blue)

Eventuali disuniformità di colore sono legate al processo tecnologico ed alla finitura manuale dei prodotti:

- Colori studiati e appositamente prodotti nei laboratori interni Serralunga.
- ☺ Clean Fighter: Speciale miscela studiata da Serralunga per rendere più facile la pulizia di qualsiasi prodotto con colorazione standard.
- ⊘ Non Clean Fighter

Eventual colour discrepancies are linked to the technological process and to the manual finishing of the products:

- Colours are studied and properly realized in Serralunga's laboratories.
- ☺ Clean Fighter. Special mixture studied by Serralunga to make the cleaning of products in standard finish, easier.
- ⊘ Non Clean Fighter

GLOSSY LACQUERED COLOURS



Bianco / LWH



Antracite / LAN



Nero / LBK



Rosso / LRO



Red Clay / LRC



Tortora / LTO

MATT LACQUERED COLOURS



Tortora opaco / LMT

MATT METALLIC LACQUERED



Azzurro / LAM



Rame / LCM



Sabbia / LSM



Titanio / LTM

GLOSSY METALLIC LACQUERED COLOURS

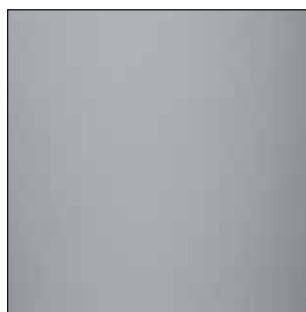

Argento / LCH



Oro / LGO

Eventuali disuniformità di colore sono legate al processo tecnologico ed alla finitura manuale dei prodotti:

- Colori studiati e appositamente prodotti nei laboratori interni Serralunga.
- ☺ Clean Fighter: Speciale miscela studiata da Serralunga per rendere più facile la pulizia di qualsiasi prodotto con colorazione standard.
- ⊘ Non Clean Fighter

Eventual colour discrepancies are linked to the technological process and to the manual finishing of the products:

- Colours are studied and properly realized in Serralunga's laboratories.
- ☺ Clean Fighter. Special mixture studied by Serralunga to make the cleaning of products in standard finish, easier.
- ⊘ Non Clean Fighter

MOLESKIN FINISHING



Moleskin Grigio / MAN



Moleskin Rose / MTC



Moleskin Mediterraneo / MWP



Moleskin Lime / MVO



Moleskin Champagne / MGS

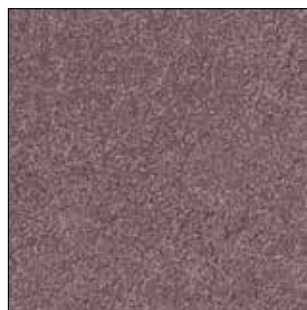

Moleskin Grape / MPR



Moleskin Terracotta / MT



MOLESKIN FINISHING

Finitura artigianale sviluppata nei laboratori Serralunga.

Moleskin è una lavorazione artigianale che viene dalla storia di Serralunga e nello specifico dall'esperienza nella lavorazione del cuoio.

Con lo spirito di ricerca ed innovazione che da sempre caratterizza l'evoluzione dell'Azienda presentiamo con orgoglio alcuni nostri prodotti con un aspetto inedito alla vista ed inaspettato al tatto.

Una lavorazione che richiama i pregiati tessuti in fustagno, tessuti robusti, caldi e confortevoli, superfici da toccare e pettinare come una pelle di daino.

Con Moleskin la resistenza e la qualità dell'arredo outdoor di Serralunga si veste di una raffinata e nel contempo tradizionale eleganza.

Handcrafted finish developed in Serralunga laboratories.

Moleskin is a craftsmanship that comes from the history of Serralunga and specifically from the experience in leather processing.

With the spirit of research and innovation that has always characterized the evolution of the company, we proudly present some of our products with an unprecedented appearance at the sight and unexpected to the touch.

A process that recalls the precious moleskin fabrics, sturdy, warm and comfortable fabrics, surfaces to touch and comb like a deerskin.

With Moleskin, the strength and quality of Serralunga's outdoor furniture get dressed in a refined and at the same time traditional elegance.

CARATTERISTICHE:

100% riciclabile. Resistente ai raggi UV e alle intemperie. Di facile manutenzione. Disponibile in 7 colori. Fornito con spugna per ripristino finitura ed istruzioni per la pulizia.

CHARACTERISTICS :

100% recyclable
UV rays and bad weather resistant
Easy maintenance
Available in 7 colours
Supplied with special sponge for maintenance and finish restoring

COLOPHON

PHOTOGRAPHY

Alessandro Paderni,
Federico Villa,
Andrea Tonella,
Stefano Lanza

Printed by

Tipolitografia Botalla srl
13894 Gaglianico (BI)
Italy

© 2025, Serralunga
100% Made in Italy

FACTORY STORE

Via Serralunga 9
13900 Biella
T +39 015 243 5711

1825 SRL

Via Serralunga 9
13900 Biella
T +39 015 243 5711
info@serralunga.com
serralunga.com

Serralunga is leading design company,
founded by Pietro Serralunga in 1825 in Biella.
The company created vases and outdoor furniture
which became some of the most important icons
of the contemporary art design panorama.

Serralunga vases are part of design permanent
collection world wide. Among them: Serpentine
gallery London, Musée d'art contemporain de
Montreal, Centre Pompidou Paris,
Triennale Design Museum Milano,
Fundació Mies Van der Rohe Barcelona.

